

Introduction to Apparel Production Workbook

Introduction to Apparel Production Workbook

AMPD 1023

LAURIE M. APPLE

UNIVERSITY OF ARKANSAS LIBRARIES
FAYETTEVILLE, AR



Introduction to Apparel Production Workbook Copyright © 2023 by Laurie M. Apple is licensed under a Creative Commons Attribution 4.0 International License, except where otherwise noted.

Contents

Introduction	1
Part I. Unit 1 Sewing Supplies and Pressing Equipment	
1. Sewing Supplies	5
2. Pressing Equipment	13
Part II. Unit 2 Fabrics	
3. Fabrics Used for Sewing Samples	19
4. Knit Fabrics	20
5. Interfacings	21
Part III. Unit 3 Pattern Envelope, Cutting and Marking	
6. Reading the Pattern Envelope	25
7. Pattern Instruction Sheet	27
8. Pattern Symbols	29
9. Cutting Pattern and Fabric	31
10. Transfer Marking of Pattern Symbols	32
Part IV. Unit 4 Learning the Parts of the Sewing Machine and Serger Sewing Machine	
11. JUKI DDL-8700 Sewing Machine	35
12. Serger	44
Part V. Unit 5 How to Thread JUKI DDL 8700 Sewing Machine	
13. Threading	49
Part VI. Unit 6 Sewing Practice and Samples	
14. Samples	53
Part VII. Unit 7 Sewing Projects	
15. Tote Bag	105

16. Skirt	111
17. Shirt	115
18. Pants	121
Appendix	125

Welcome to Introduction to Apparel Production. Whether you are part of the college class or learning on your own, you will gain important concepts and techniques in beginning apparel production. This workbook is to accompany the activities through in person teaching or online learning. There will be graphics and videos to help guide you through each step of this workbook. There are 6 learning units and a sewing projects unit in this workbook. The sewing projects unit contains 4 projects: tote bag, skirt, shirt and pants. The pattern numbers may change due to the availability of patterns.

- Unit I: Sewing Supplies and Terminology
- Unit II: Fabrics and Materials Used in Sewing
- Unit III: Pattern Envelope, Cutting and Marking
- Unit IV: Learning the Parts of the Sewing Machine and Serger
- Unit V: How to Thread JUKI DDL 8700 Sewing Machine
- Unit VI: Sewing Practice and Samples
- Unit VII: Sewing Projects

PART I

UNIT 1 SEWING SUPPLIES AND PRESSING EQUIPMENT

The sewing supplies and pressing equipment are defined and shown in this section. You will need to purchase the needed supplies for the samples and projects. Becoming familiar with the pressing equipment will ensure the safe operation of the equipment.

1. Sewing Supplies

Sewing Supplies Needed



Shears are designed for sewing production and are longer in length than typical scissors. They have different size holes for the thumb and fingers. Shears should not be used to cut anything but fabric as cutting paper will dull the blades quickly.



Tape Measures are designed made of cloth or plastic with the flexibility to accurately measure the circumference of the body. The tape measure has markings in both inches and centimeters.

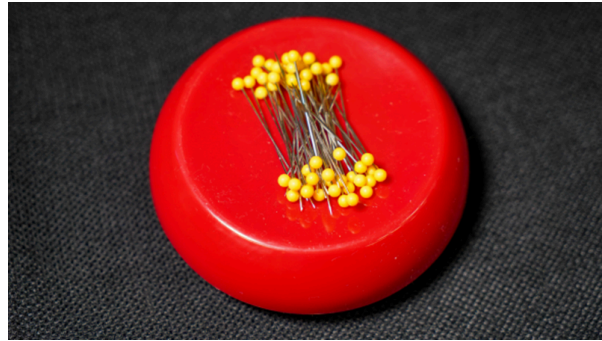

Roundhead quilting/dressmaking pins are best for sewing with fabric as they are longer in length, have a sharp point, and are easy to grasp by the round head. Pincushions are used to hold the pins, whether cloth or magnetic. The magnetic pincushion is pictured.



Marking pens/chalk pencils are used to transfer crucial markings from the pattern to the fabric. The type and color of the fabric determines the best method for transferring markings.



Seam Rippers are used to remove seams and threads. They typically have a longer sharp point to easily be inserted into a stitch for cutting and a shorter point with a protective balled cap to prevent ripping fabric.



Hand sewing needles come in a variety of sizes and lengths as well as sharp or ballpoint. The most common type of hand sewing needle is a sharp needle in sizes 5-10. The smaller the needle number the larger the needle. Jjneedles.com gives you a free downloadable guide to types of hand sewing needles. (Jjneedles.com)

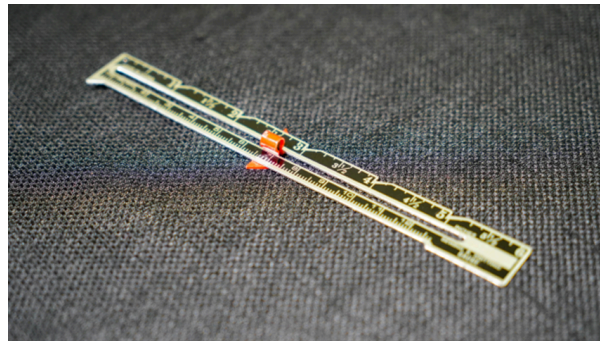

Seam Guide/Sewing Gauge will allow you to measure accurately. It has a sliding bar that will stay in place while you measure things like hems, buttonhole markings, pleat depths, etc.



Snaps come in a variety of sizes. The size used depends on the garment to which it will be sewn. They are made from either chrome metal, black metal, or clear plastic.



Hooks and Eyes are for closures. They range in sizes that relate to the garment to which it will be sewn. There are different types of eyes, flat or round that are used with the same type of hook. There are also skirt/pant hooks that are wide and flat for closures of waistbands on skirts and pants.



Buttons are used as a type of closure. There are numerous varieties of button shapes, sizes, and colors. The two main types of buttons are flat and shanked buttons. The buttons needed for the shirt project in this course are flat buttons flat with four holes. There are shirt buttons with two holes that will work also.

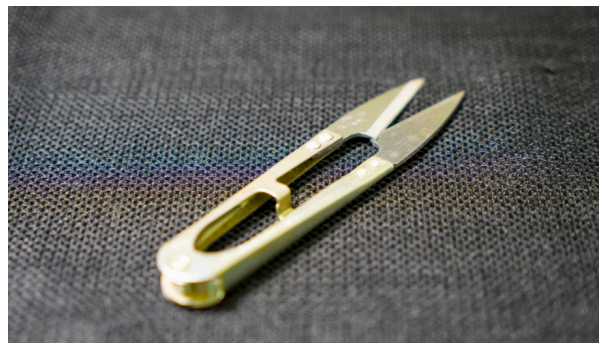

Thread Clippers are smaller than shears and are used to clip threads quickly. They can be used to cut open buttonholes and are a good tool to have when sewing.



Zippers are closures that come in different varieties, from separating zippers found in coats to all-purpose zippers and invisible zippers: You will need 2 all-purpose zippers and 1 invisible zipper for your sample notebook. You will need additional zippers for your skirt and pants projects.



Needle threaders are used to help either thread a machine or hand needle.



Bias tape is used in a variety of sewing techniques and comes in a variety of widths and folds. It is general used to cover a seam allowance or raw edge. You will need 1 package of extra wide double fold bias tape. You will use bias tape for a sample in your notebook called the Hong Kong Seam Finish.



Fusible Fleece will be used in the tote bag to give the bag more body and stability. You will need 1 yard.



Fusible Interfacing comes in various weight depending on the weight of the fabric. You will need 2 yards of midweight fusible interfacing to be used for the shirt, skirt and pants.

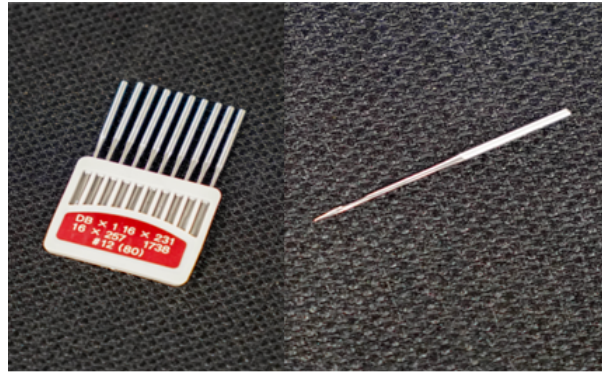

Machine and hand sewing needles are designed with a sharp or ballpoint and an eye for threading. Machine needles are specific to types of machines. Check your manual to determine the best machine need for your machine. Sharp needles are used when sewing with woven fabrics and ballpoint needles are used for knits.

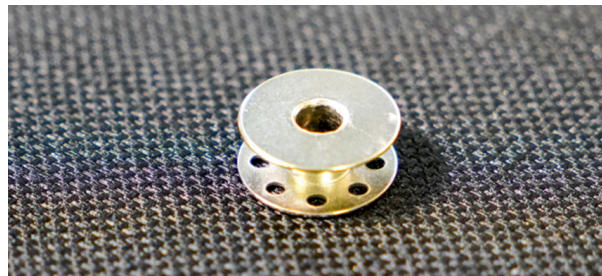

Bobbins are used to hold the lower thread of the stitch.



Bobbin Case is used to hold the bobbin and is inserted in the lower part of the machine. This picture is of the lever side and the open of a bobbin case.

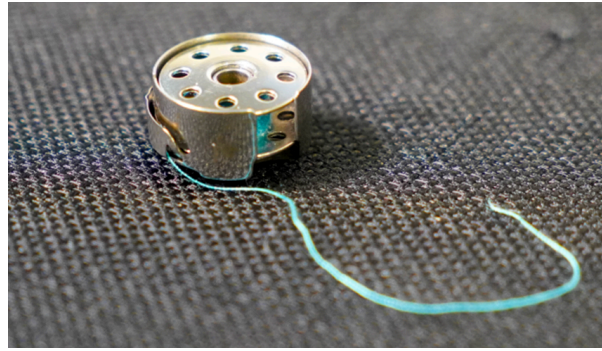

The bobbin fits in the open side on the post and is threaded through the tension bar.

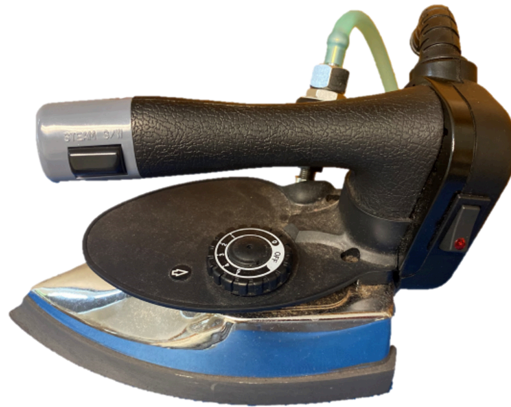

Irons are used for pressing and forming fabric. The heat and steam from an iron is also used to adhere fusible interfacings to parts of fabrics that need stability.

2. Pressing Equipment

Irons are used for pressing and sometimes forming fabric. The heat and steam from an iron is also used to adhere fusible interfacings to parts of fabrics that need stability.

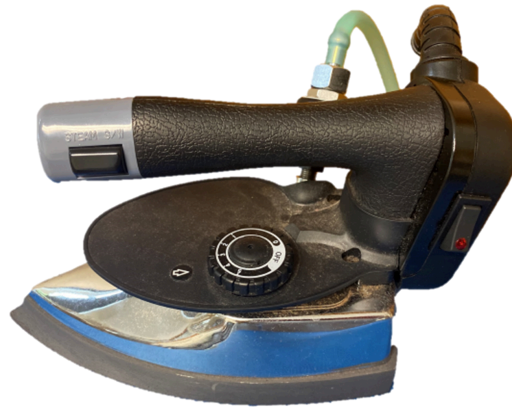

Vacuum Ironing Board Tables use a vacuum system to hold fabric in place while ironing and also allow for fast drying of damp items. There is an attached swing arm to get into smaller spaces such as sleeves, necklines, etc.



PART II

UNIT 2 FABRICS

A. FABRICS USED in SEWING SAMPLES

Fabric for samples should be 100% cotton solid woven. If you are enrolled in AMPD 1023 Introduction to Apparel Production, this fabric will be selected for you and can be purchased during the supplies trip. A safe fabric is considered quilting fabric.



B. FABRICS USED for SEWING PROJECTS

1. Tote Bag Fabric – You will need 3 different fabrics for your tote bag. One for the body of the bag, one for the contrast at the top of the bag and one for the lining. The tote bag body and contrast fabric needs to be a heavier fabric suitable for holding the weight of the contents of the bag. This type of fabric needs to be 100% cotton and can be denim, twill, drapery, upholstery or outdoor fabric. Make sure the fabric is not too stiff or it will be hard to sew. The lining fabric also needs to be 100% cotton in a lighter weight fabric similar to the sample fabric. You can choose any pattern or colors in muslin, broadcloth or cotton. Have fun with combining prints and colors. In addition, you will need 1 yard of fusible fleece.



2. Skirt Fabric—The skirt pattern is a straight skirt with an invisible zipper and facing. If you are in AMPD 1023 the skirt pattern will be provided for you. If you are working independently you can use Simplicity Pattern #1559. You will need a 100% cotton fabric suitable for skirts/pants. This fabric can be light weight denim or twill. **DO NOT PURCHASE FLANNEL, CORDUROY, VELVET, LEATHER.**

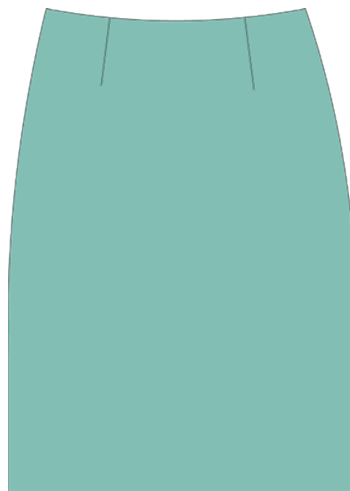

Skirt Front

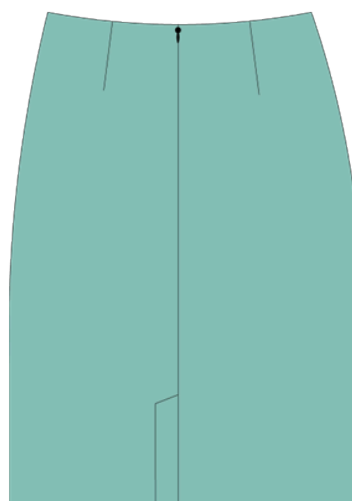

Skirt Back

3. Shirt Fabric— The shirt pattern is a basic men's shirt (Simplicity #1544) with collar and collar band, long sleeves with sewn placket and cuffs. You will need 100% shirt fabric. It is best to choose a print fabric so you can determine the front and the back of the fabric.



4. Pants Fabric—The pants pattern (Simplicity #1520) is an elastic waist straight leg pants. You will need a 100% woven cotton fabric suitable for lounge pants. This fabric can be light weight denim, broadcloth, chambray, or poplin . DO NOT PURCHASE KNIT, FLANNEL, CORDUROY, VELVET, LEATHER.



C. INTERFACINGS USED for SEWING PROJECTS

Fusible Fleece will be used for the tote bag.



Fusible interfacing will be used for the skirt and shirt.



3. Fabrics Used for Sewing Samples

Fabric for samples should be 100% cotton solid woven. If you are enrolled in AMPD 1023 Introduction to Apparel Production, this fabric will be selected for you and can be purchased during the supplies trip. A safe fabric is considered quilting fabric.



4. Knit Fabrics

Knit fabrics have an interlooping structure and stretch. We will not be using any types of knits during this class.

5. Interfacings

We will be using two types of interfacing during this class. The first interfacing is for your tote bag. It is called fusible fleece. This will give structure and body to your bag. The second type is for apparel and is called fusible interfacing (shirt weight). Make sure you get the shirt or mid weight interfacing to give you stability in the collar, cuffs and placket areas of your shirt and for the waistband of your skirt.

PART III

UNIT 3 PATTERN ENVELOPE, CUTTING AND MARKING

6. Reading the Pattern Envelope

Patterns

Commercial patterns are packaged in a pattern envelope. The envelope has specific information for size, fabric recommendations and the amount needed, notions, level of difficulty, front and back pictures or sketches and design variations. On the front of the pattern envelope is the company or designer name, pattern number, front views of the design variations, and some times size range.

A. Front of Envelope



B. Back of Envelope

Fabric Suggestions **1544**
15 PIECES/PIEZAS

Notions Needed

Body Measurements

Sizes

Fabric Yardage Needed
For each view

Back Views

Contrast Fabric
and Interfacing

Garment Measurements

1544
15 PIECES/PIEZAS

MEN'S SHIRT WITH FABRIC VARIATIONS

Fabrics: Flannel, Laminated Cottons, Baby Cord, Broadcloth, Chambray, Lightweight Denim, Pinweave Corduroy, Poplin, Handkerchief Linen. Extra fabric needed to match plaids, stripes or one-way design fabrics.

Notions: Thread **A,B,C**; Ten **1/2"** buttons; **C**; Twelve studs; **D**; Twelve **7/8"** buttons. Look for Simplicity Trims.

BODY MEASUREMENTS

Chest	34	36	38	40	42	44	46	48	50	52	In
Waist	28	30	32	34	36	39	42	44	46	48	"
Hip	35	37	39	41	43	45	47	49	51	53	"
Neck Band	14	14½	15	15½	16	16½	17	17½	18	18½	"

Sizes	34	36	38	40	42	44	46	48	50	52
Size-Range	44	46	48	50	52	54	56	58	60	62

A Shirt	2½	2½	2½	2½	2½	2½	2½	2½	2½	2½	Yd
45***	2	2	2	2	2	2	2	2	2	2	"
60***	2	2	2	2	2	2	2	2	2	2	"

B Shirt	2½	2½	2½	2½	2½	2½	2½	2½	2½	2½	Yd
45***	2	2	2	2	2	2	2	2	2	2	"
60***	2	2	2	2	2	2	2	2	2	2	"

C Shirt	2½	2½	2½	2½	2½	2½	2½	2½	2½	2½	Yd
45***	2	2	2	2	2	2	2	2	2	2	"
60***	2	2	2	2	2	2	2	2	2	2	"

D Shirt	2½	2½	2½	2½	2½	2½	2½	2½	2½	2½	Yd
45***	2	2	2	2	2	2	2	2	2	2	"
60***	2	2	2	2	2	2	2	2	2	2	"

A,B Contrast ½ yd. of 45" or 60"***
A,B,C,D Interfacing, including **D** Flaps - 1 yd. of 20" to 25" lightweight fusible, such as Pellon®; Ribbon (opt.) 1 yd. of ¾" wide

GARMENT MEASUREMENTS (Chest Printed on Pattern Tissue)
All Views Chest 40 42 44 46 48 50 52 54 56 58 In

HOMME: CHEMISE EN DIFFERENTS TISSUS

Tissus: Flanelle, Cotons prélavés, Piqué très fin, Popeline, Chambray, Denim léger, Velours, Mûlerases, Popeline fine, Lin très fin, Préréglé avantage de tissu pour raccorder les épaules. Les rayures ou les motifs unidirectionnels.

Merciérie: Fil **A,B,C**; Dix boutons de 1,3cm; **C**; Douze boutons décoratifs; **D**; Douze boutons de 1,3cm; Demandez les garnitures de Simplicity.

HOMBRES: CAMISA EN DIFERENTES TELAS

Telas: Flanela, Algodones lavados, Piqué muy fino, Popelina, Chambray, Drill ligero, Terripelo Mil raras, Popelina fina, Lino muy fino. Se necesita tela adicional para cerrar cuadros, rayas o telas estampadas en una dirección.

Merciérie: Hilo **A,B,C**; Diez botones de 1,3cm; **C**; Doce clavos decorativos; **D**; Doce botones de 1,3cm; Pida las adorno de Simplicity.

MESURES NORMALISEES/ MEDIDAS DEL CUERPO
Palmes/ Pecho 87 92 97 102 107 112 117 122 127 132 cm
Taille/ Cintura 71 76 81 87 92 99 107 112 117 122 "

Hanches / Caderas 89 94 99 104 109 114 119 124 130 135 cm
Bande de col / Banda de cuello 35.5 37 38 39.5 40.5 42 43 44.5 45.5 47 cm

Tailles 34 36 38 40 42 44 46 48 50 52
Fransise 44 46 48 50 52 54 56 58 60 62

A Chemise/ A Camisa
115cm*** 2.10 2.10 2.20 2.30 2.30 2.40 2.40 2.40 2.50 2.60 m
150cm*** 1.80 1.80 1.80 1.90 1.90 2.00 2.00 2.10 2.20 "

B Chemise/ B Camisa
115cm*** 2.30 2.30 2.30 2.40 2.40 2.40 2.60 2.60 2.70 3.00 m
150cm*** 1.80 1.80 1.90 2.10 2.10 2.10 2.20 2.20 "

C Chemise/ C Camisa
115cm*** 2.40 2.40 2.50 2.50 2.50 2.60 2.70 2.70 2.80 3.00 m
150cm*** 1.90 1.90 2.00 2.10 2.10 2.10 2.10 2.20 2.20 "

D Chemise/ D Camisa
115cm*** 2.20 2.30 2.30 2.30 2.40 2.60 2.60 2.70 2.70 m
150cm*** 1.80 1.80 1.90 1.90 1.90 1.90 2.10 2.10 "

A,D Parties Contrastantes 0,70m de 115cm ou 150cm***
A,B,C,D Entolage - y compris les Rabats **D** - 0,90m de 51cm à 64cm, léger, noncontrastant; les que **Palmes/ Rabat/ Flaps** **C** - 0,90m de 51cm de large.

A,B,C,D Entrelatez- incluye las Solapas **D** - 0,90m de 51cm a 64cm, ligera, adhesiva como Pellon®; **Cinta (opcional)** - 0,90m de 1cm de ancho.

This book is published by permission of the publisher of the original work. All rights reserved. No part of this book may be reproduced, stored in a retrieval system, or transmitted in any form or by any means, electronic, mechanical, photocopying, recording, or by any information storage and retrieval system, without the prior written permission of the publisher.

7. Pattern Instruction Sheet

The pattern instructions sheet has 5 main sections.

A. Description and Views



B. Pattern Pieces

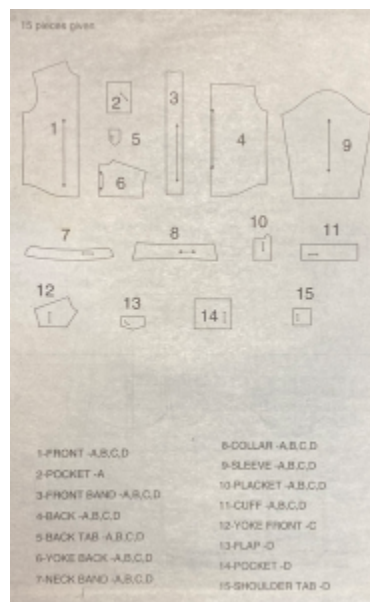

C. Symbols and Glossary of Terms

General Directions

The Pattern

SYMBOLS

GRAIN LINE Place on straight grain of fabric parallel to selvage

PLACE SOLID LINE on fold of fabric.

CENTER FRONT OR BACK of garment.

NOTCHES

DOTS

CUTTING LINE

LENGTHEN OR SHORTEN LINES

SEAM ALLOWANCE: 5/8" (1.5cm) unless otherwise stated is included and not printed on **MULTI-SIZE PATTERNS**. Mark your size with colored felt tip pen. See chart on tissue for how to use **MULTI-SIZE PATTERNS**.

ADJUST IF NEEDED
Make adjustments before placing pattern on fabric.

TO LENGTHEN:
Cut pattern between lengthen or shorten lines. Spread pattern evenly, the amount needed and tape to paper.

TO SHORTEN:
At lengthen or shorten lines, make an even pleat taking up amount needed. Tape in place.

When lengthen or shorten lines are not given, make adjustments at lower edge of pattern.

Cutting/Marking

BEFORE CUTTING:
PRESS pattern pieces with a warm dry iron. PRE-SEW the fabric by pre-washing, washables or steam-pressing non-washables.

CIRCLE your cutting layout.

PIN pattern to fabric as shown in Cutting Layouts.

- FOR DOUBLE THICKNESS: Fold fabric with RIGHT sides together.
- FOR SINGLE THICKNESS: Place fabric RIGHT side up.
- FOR PLE, SHADED OR ONE WAY DESIGN FABRICS: Use "with nap" layouts.

AFTER CUTTING:
Transfer markings to WRONG side of fabric before removing pattern. Use pin and chalk method or dressmaker's tracing paper and wheel.

To Quick Mark:

- Snip edge of fabric to mark notches, ends of fold lines and center lines.
- Pin mark dots.

SPECIAL CUTTING NOTES

★ If layout shows a piece extending past fold, cut out all pieces except piece that extends.

Open old fabric to single thickness. Cut extending piece on RIGHT side of fabric in position shown.

✂ Mark small arrows along both selvages indicating direction of nap or design. Fold fabric crosswise with RIGHT sides together, and cut along fold (a).

Turn one fabric layer around so arrows on both layers go in the same direction. Place RIGHT sides together (b).

Sewing

- SEW garment following Sewing Directions.
- PIN or machine-baste seams matching notches.
- STITCH 5/8" (1.5 cm) seams unless otherwise stated.
- PRESS seams open unless otherwise indicated clipping when necessary so seams will lie flat.
- TRIM seams to reduce bulk, as shown below.

Trim enclosed seams into layers

Trim corners

Clip inner curves

Notch outer curves

D. Cutting Layouts for Fabrics and Interfacing

Cutting Layouts

Legend: fabric pattern, pattern pieces, pattern pieces

NOTE: SIDE OF PATTERN PIECES MAY VARY SLIGHTLY ACCORDING TO YOUR PATTERN SIZE.

A SHIRT

USE PIECES 1, 2, 3, 4, 5, 7, 8, 11, 12
WITH NAP
SIZE: 34-36-38-40-42
CUT ONE OF PIECE 2

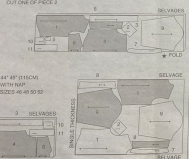

B SHIRT

USE PIECES 1, 2, 4, 5, 6, 7, 8, 10, 11
WITH NAP
SIZE: 34-36-38-40-42
CUT ONE OF PIECE 2

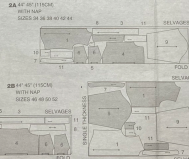

C SHIRT

USE PIECES 1, 2, 4, 5, 6, 7, 8, 10, 11, 12
WITH NAP
SIZE: 34-36-38-40-42

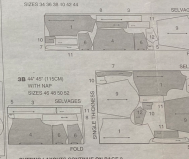

CUTTING LAYOUTS CONTINUE ON PAGE 5

E. Sewing Instructions

Sewing Directions

FABRIC KEY: RIGHT SIDE, WRONG SIDE, INTERFACING

Read **General Directions** on page 1 before you begin.

SHIRT A, B, C, D

NOTE: Ribbon trim for front band is optional.

- Stay-stitch neck edge of front, neck edge of yoke back 1/2" (1.3cm) from cut edge in direction of arrows. This stitching stays in permanency and helps prevent stretching on curved edges. Stay-stitching will not be shown in the following illustrations.

POCKET A

- Press under 1/4" (6mm) on upper edge of pocket. Turn upper edge to OUTSIDE along fold line, forming facing. Stitch along seam line on raw edges. Trim seam allowance in the facing area to 1/4" (6mm).

POCKET AND FLAP D

- Turn corners RIGHT side out, turning facing to the WRONG side; press, pressing under raw edges along stitching. Stitch facing close to inner edge.
- On OUTSIDE, pin pocket to front placing upper corners at large dots. Stitch close to side and lower edges.

POCKET AND FLAP D

- To make inverted pleat, on OUTSIDE, bring broken lines together. Stitch along broken lines.
- Press pleat flat bringing stitching to center. Baste across upper and lower edges.
- To EDGE FINISH upper raw edge of pocket...stitch under 1/4" (6mm), zig-zag OR overlock/serge. Turn upper edge to OUTSIDE along fold line, forming facing. Stitch along seam line on raw edges. Trim seam allowance in the facing area to 1/4" (6mm).
- Turn corners RIGHT side out, turning facing to the WRONG side; press, pressing under raw edges along stitching. Stitch facing close to inner edge.
- On OUTSIDE, pin pocket to front placing upper corners at large dots. Stitch close to side and lower edges and 1/4" (6mm) away, as shown.

8. Pattern Symbols

Symbols on patterns give a variety of information including cutting lines, stitching lines, alternation lines, button/buttonhole placement, fold lines and dots and notches, which help match the pieces during construction.

1.Solid and open dots—indicated placement to match seams or construction details, i.e. pocket placement, pleats, gathers, etc.



2.Single notch—indicates the front of a garment piece and is used to match pattern pieces for construction.



3.Double notches—indicate the back of a garment piece.



4.Double ended arrow line— used to indicate grain line.



5.Double ended bent arrow line-used to indicate grain and to place pattern piece on the fold of the fabric.

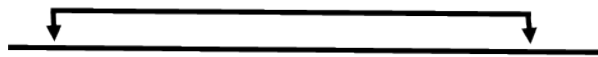

6.Dotted line indicates stitching line. The distance between the dotted line and solid line is the seam allowance.



7.Solid line on the outer edge of the pattern piece indicates where to cut the pattern piece.

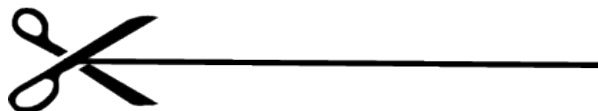

8. Double solid lines on a pattern indicate where to lengthen or shorten a pattern piece for alternations.



9. The crossed circle indicates the apex of fullness. Usually located at the bust line and hip line.

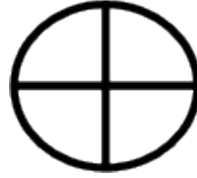

10. The X indicates where to place buttons.



11. The line with end bars indicate buttonhole placement and length of buttonhole.



9. Cutting Pattern and Fabric

10. Transfer Marking of Pattern Symbols

Using a marking pen/pencil tailors chalk or tracing paper/wheel to mark necessary symbols specific to the project pattern instructions. See video clips of each project to determine what symbols need to be transferred.

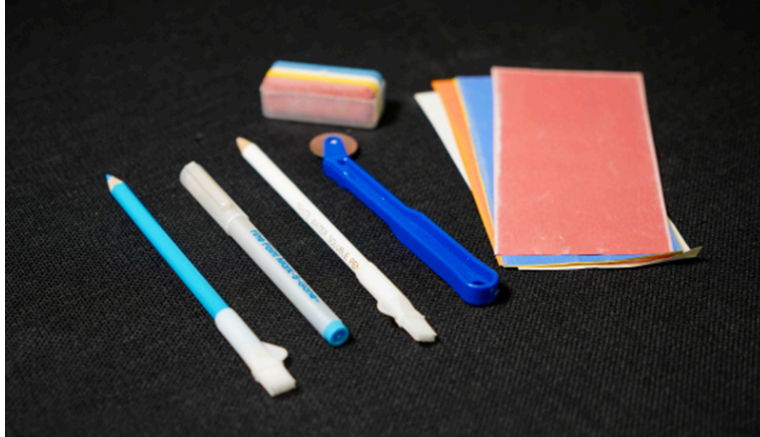

PART IV

UNIT 4 LEARNING THE PARTS OF THE SEWING MACHINE AND SERGER SEWING MACHINE

It is essential that you learn the parts of your sewing machine prior to sewing. The JUKI machines used in the production lab for AMPD 1023 are industrial machines with many moving parts. Knowing the parts of your machine and what each part does will ensure the safe operation of the machine.

The serger will be used to finish seam edges. There are parts of the serger you will need to become familiar with in order to safely operator the machine. There is a knife edge that will cut fabric and if you do not know where it is located or how it works, you may cut fabric unintentionally or cut yourself.

11. JUKI DDL-8700 Sewing Machine

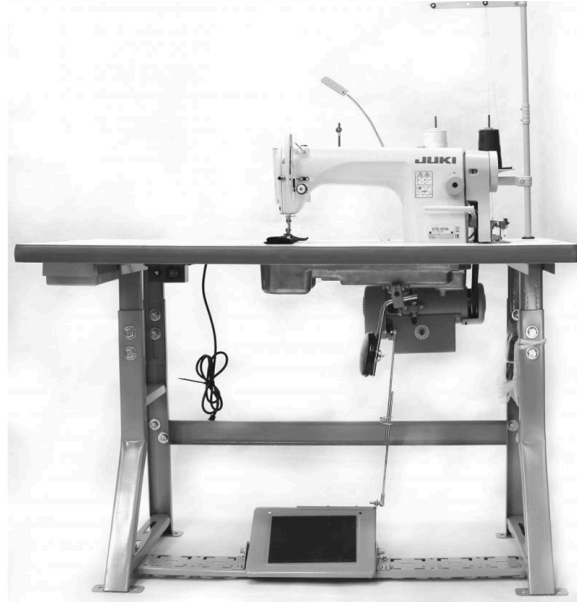

A. UPPER PART OF MACHINE

1. Machine Table – The table holds the machine head and allows for garment space while sewing.

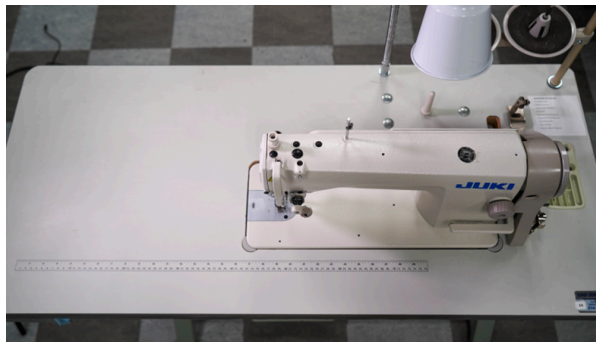

2. Machine Head -The machine head controls the upper thread, thread tension, stitch length control, backstitch lever and needle housing.



3. Thread Stand – The thread stand holds the cones of thread for the upper threading of the machine head.



4. Hand Wheel – The hand wheel allows you to control the movement of the needle manually.



5. Backstitch Lever – The backstitch lever controls the directions of the stitching by allowing the machine to stitch backwards to secure the stitching line.



6. Stitch Length Dial – The stitch length dial controls the length of stitches. Average stitch length for seams is 2.5-3.

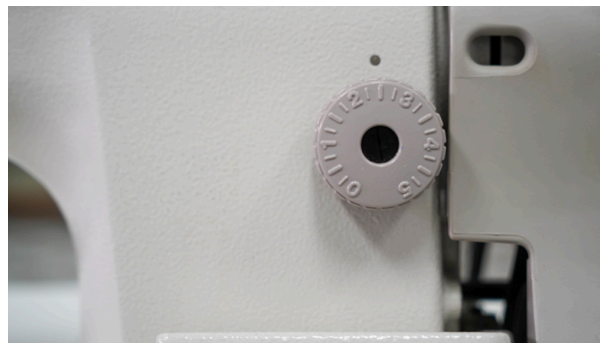

7. Tension Dial – The tension dial controls the amount of tension placed on the upper thread. There should be no need to change the tension dial once set for standard fabrics.

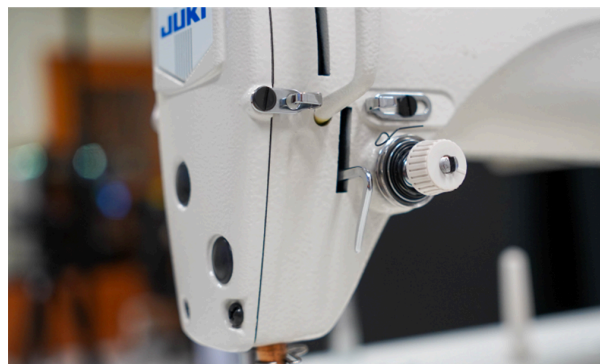

8. Throat Plate – The throat plate covers the lower bobbin housing and allows the feed dog (serrated feet) to move the fabric forward while stitching. It also has seam allowance markings.

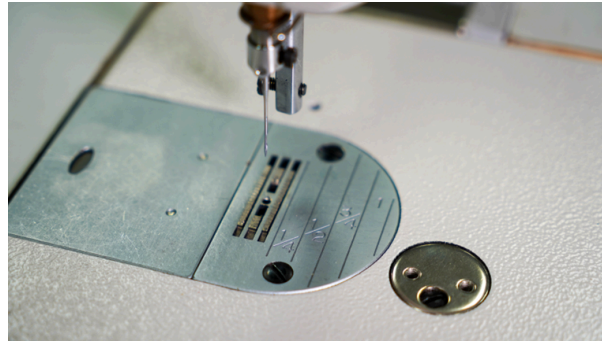

9. Bobbin Plate Cover – The bobbin plate cover hides the bobbin case mechanism that holds the lower thread. It slides to the left to open and see into the bobbin case housing.

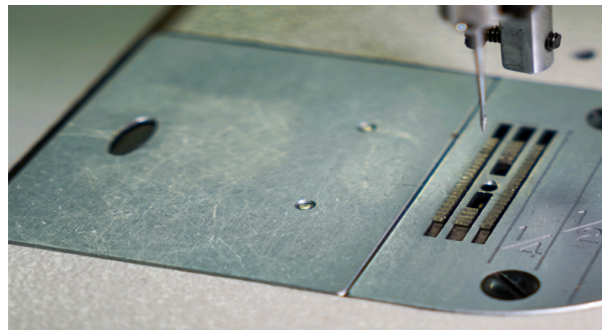

10. Bobbin Winding Mechanism – The bobbin winding mechanism is located on the right side of the machine. It is used to wind the bobbin with the lower thread for stitching.



11. Presser Foot and Needle Shank – The presser foot holds the fabric in place while stitching. It lifts and lowers with a lever on the back of the machine head or by the knee lifter under the machine table. The needle shank holds the needle in place while stitching.



12. Table Light – The table light is located toward the back of the table and is adjustable on a flexible arm. The power switch is located on the top of the light and if left on will turn on and off with the machine power button.



B. LOWER PART OF MACHINE

1. Power Switch – The power switch is located just under the table on the right side of the machine table.

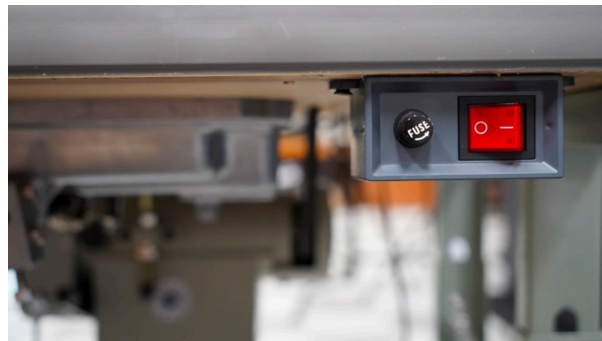

2. Knee Lifter – The knee lifter controls the lifting and lowering of the presser foot.

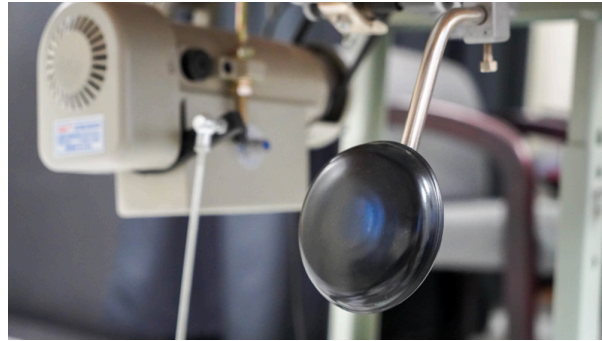

3. Foot Peddle – The foot peddle controls the operating of the machine.



4. Motor Speed Dial – The motor speed dial is located on the motor housing and is adjustable from 0—3450. Average speed for class is 350.

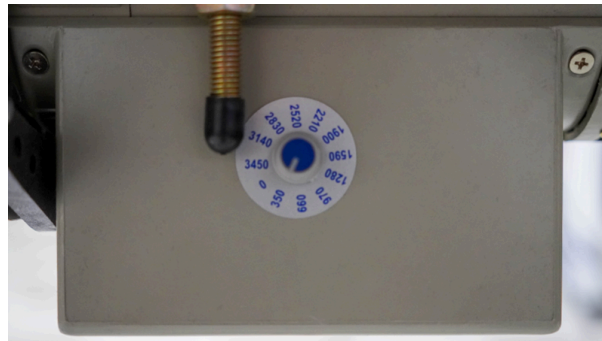

C. ACCESSORIES

1. Bobbin Case – The bobbin case holds the bobbin full of thread. Show here are both sides of the bobbin case.



2. Bobbin – The bobbin holds the lower thread and is inserted into the bobbin case to be placed in the lower part of the machine.

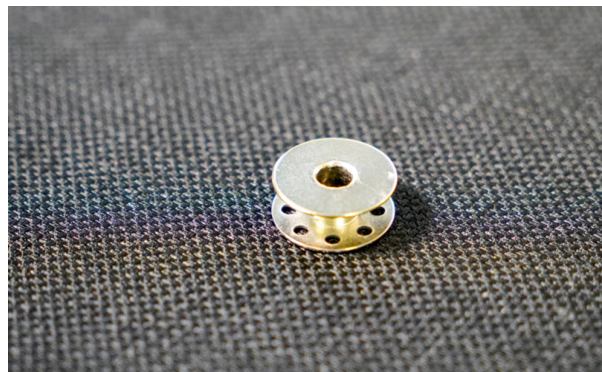

3. General Straight Stitch Presser Foot – This presser foot holds the fabric in place while stitching. The general presser foot is shown here.



4. Invisible Zipper Foot – The invisible zipper foot is grooved on the bottom for zipper teeth to glide through and provide a concealed zipper for polyester or nylon zippers.



5. Slim Zipper Foot – The slim zipper foot with a notch on the side is used to insert lapped, center and fly front zippers. This foot can also be used to get into tight corners and attaching piping.



6. Machine Needle – The machine needle for the lockstitch sewing machine has a shank, shaft and eye. Sizes vary upon fabric choice.



7. Drawer Contents – Each machine has an accessories drawer located under the edge on the left side of the machine table. Located in the drawer is a box with a bobbin case, invisible zipper foot and slim zipper foot. This box and its contents stay with the machine at all times. In addition, the drawer will have a screwdriver for changing out the presser feet and for changing the needle.



12. Serger

A. UPPER PART OF SERGER

1. Machine Table-The table holds the serger machine head and allows for garment space while serging. It also holds the thread cone stand holding 3-4 cones of thread.



2. Serger Head – The serger head controls the upper threads, thread tensions, and needle and knife housing.



3. Knife and Needle Area

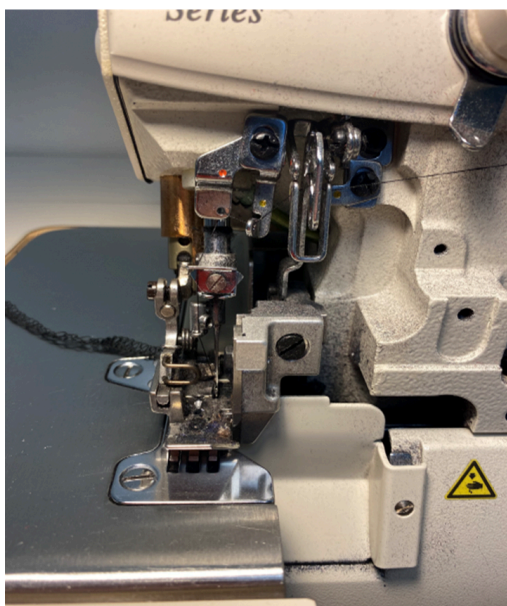

4. Power Switch -The power switch is located under the table edge on the right side of the machine turns on the machine and the light.



5. Fabric Shoot -The fabric shoot allows the cut off fabric to be deposited into a waste bin.

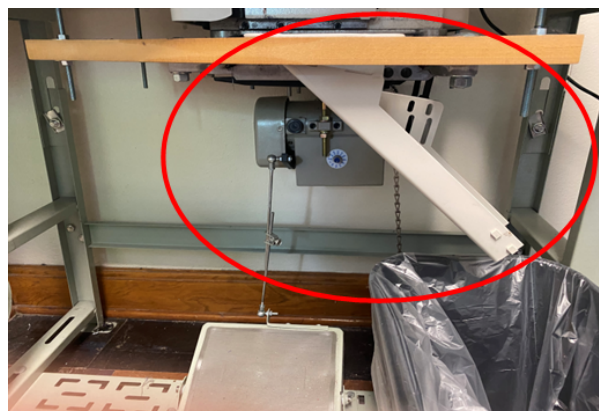

6. Foot Peddle – The foot peddle drives the serger.



7. Presser Foot Lifter -The presser foot lift is located next to the foot peddle. It lifts and lowers the presser foot of the serger.

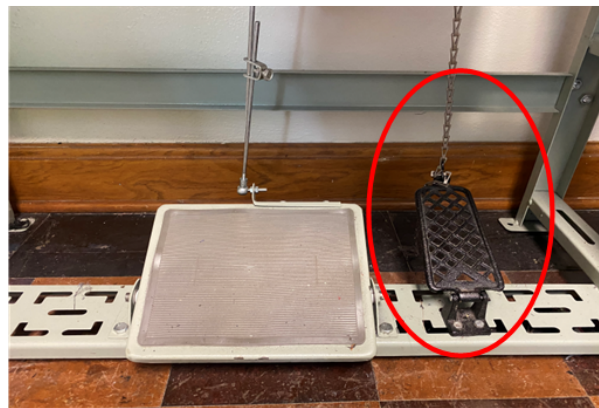

PART V

UNIT 5 HOW TO THREAD JUKI DDL 8700 SEWING MACHINE

Learning how to thread the JUKI DDL 8700 is critical for the machine to operate properly. If there is a slight miss on any of the threading, your machine will not stitch properly and may result in knotting on the underside of the fabric or breaking the thread or needle.

13. Threading



One or more interactive elements has been excluded from this version of the text. You can view them online here: <https://uark.pressbooks.pub/introapparelproductionworkbook/?p=145#oembed-1>

PART VI

UNIT 6 SEWING PRACTICE AND SAMPLES

Practice

Samples

Types of Seams

Types of Seam Finishes

Stitching Techniques prior to Garment Construction

Stitching Techniques after Garment Construction

Hand Stitches

Closures

14. Samples

A. Practice Sewing

Cut a set of 5" by 7" sample fabric. With right sides together, stitch 5 lines lengthwise 1" apart back tacking at the beginning and end of each stitched line. Insert completed sample in the Sample notebook.

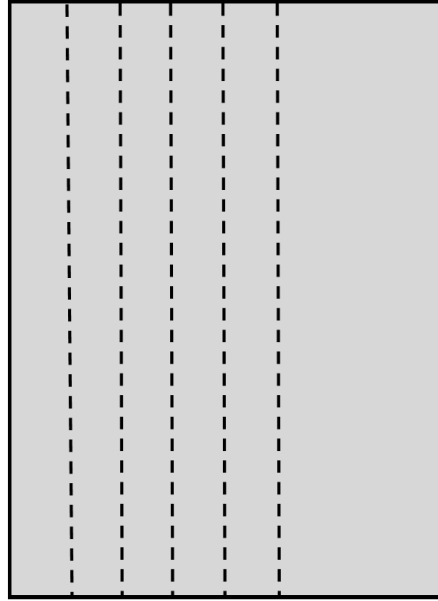

B. Sample Cutting

Cutting out samples. You will need 19 sets of 5" X 7" sample fabric on grain; 3 samples measuring 4" X 5"; and the remaining samples cut from the patterns in the back of this manual.

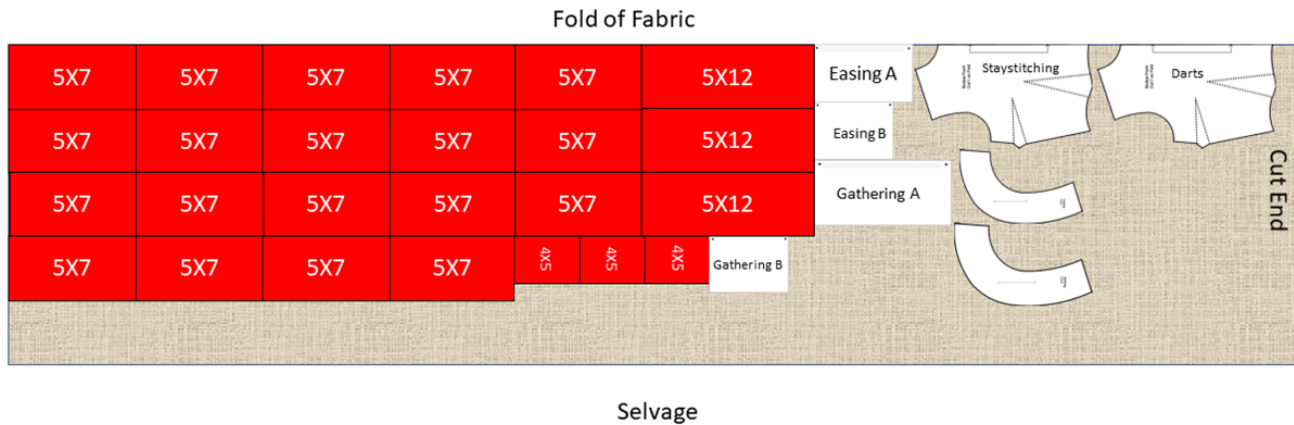

For the red 5 x 7 samples, measure from the fold in 5" increments, then measure up in 7" measurements. Mark with A sharpie. Mark the 3 5 x 12 and 3 4 X 5 samples with a sharpie.

For the white patterns, cut out from the pattern in the back of the book and pin to fabric as shown, cut out.

C. Samples

For all sample instructions, gray indicates wrong side of fabric and white indicates right side of fabric.

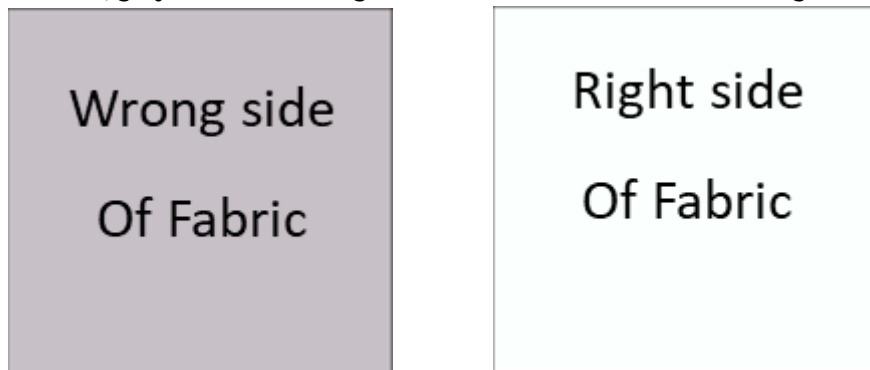

1. Types of Seams

a. Plain – Use 1 set of 5" x 7" sample fabric Use 1 set of . With right sides together, stitch a straight seam 1/2" from edge of fabric. Unfold sample and pressing seam allowance open. Using a sharpie, label the sample "plain seam" and place in your sample notebook.

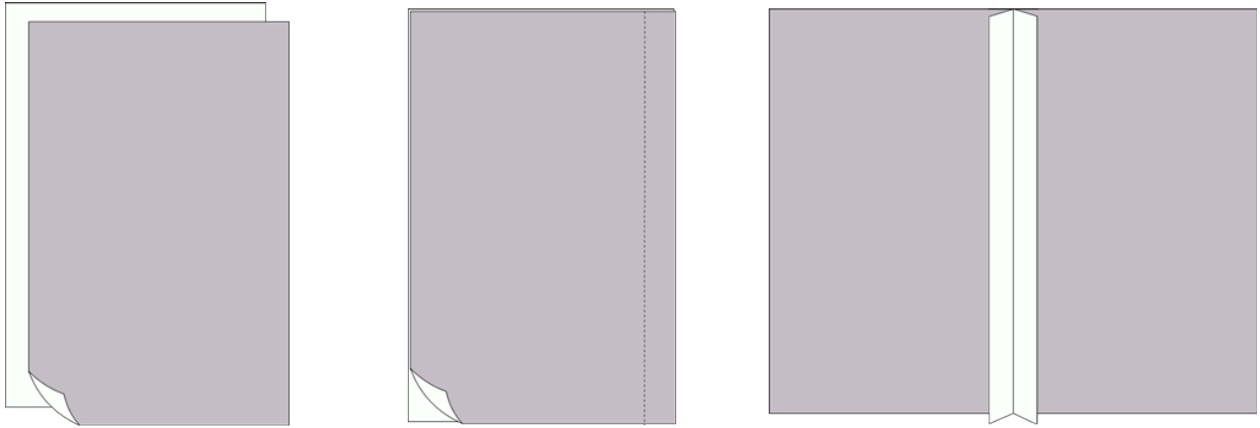

b. Mock Welt—Use 1 set of 5" x 7" sample fabric. Start by repeating steps 1-3 of the plain seam. Trim the right side of the seam allowance to 1/4 ". Fold left seam allowance over trimmed right seam allowance and press. Turn to right side and topstitch 1/4" from seam line. Label "Mock Welt Seam".

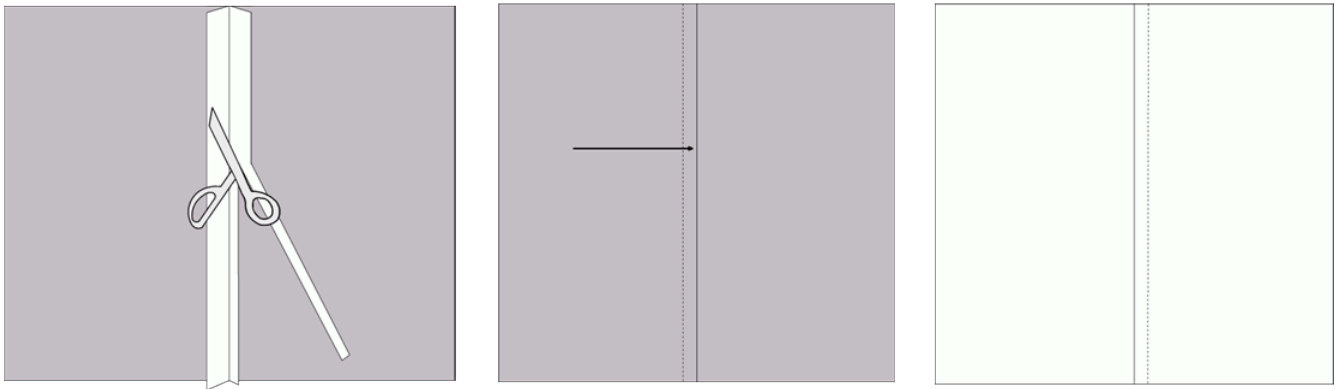

c. French—Use one set of 5" X7" sample fabric. Place fabric wrong sides together. Stitch 1/4" seam.

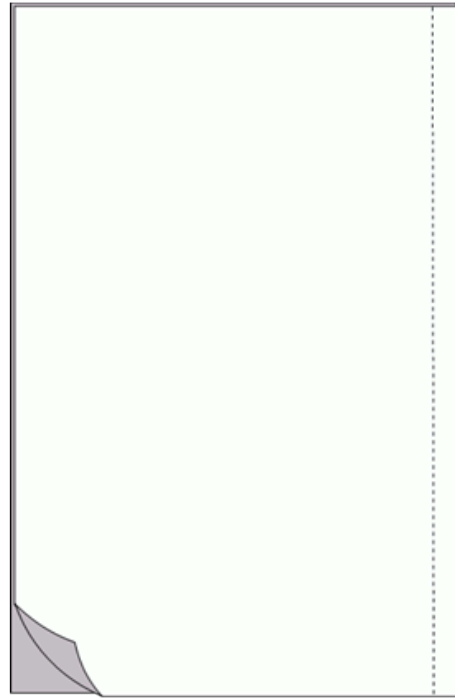
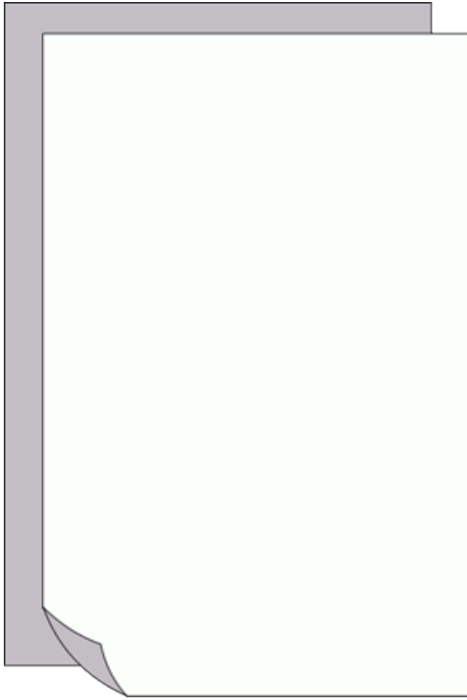

Turn fabric with right sides together, seam will be on the inside. Press and stitch at 1/4".

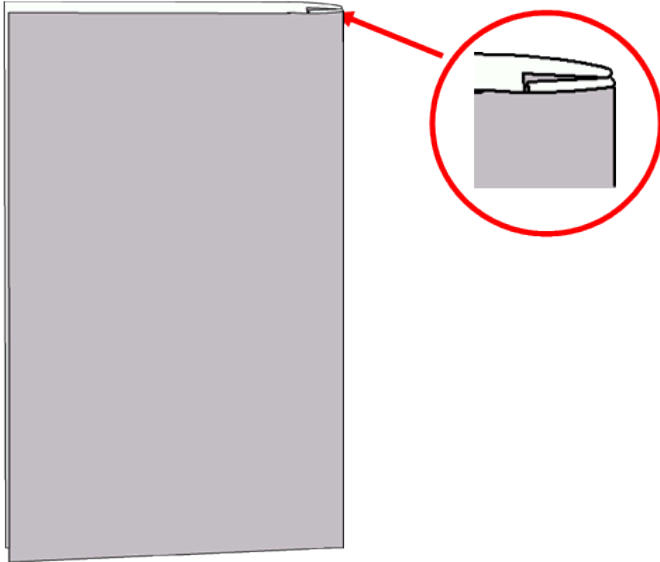

Lay sample flat and label "French Seam".

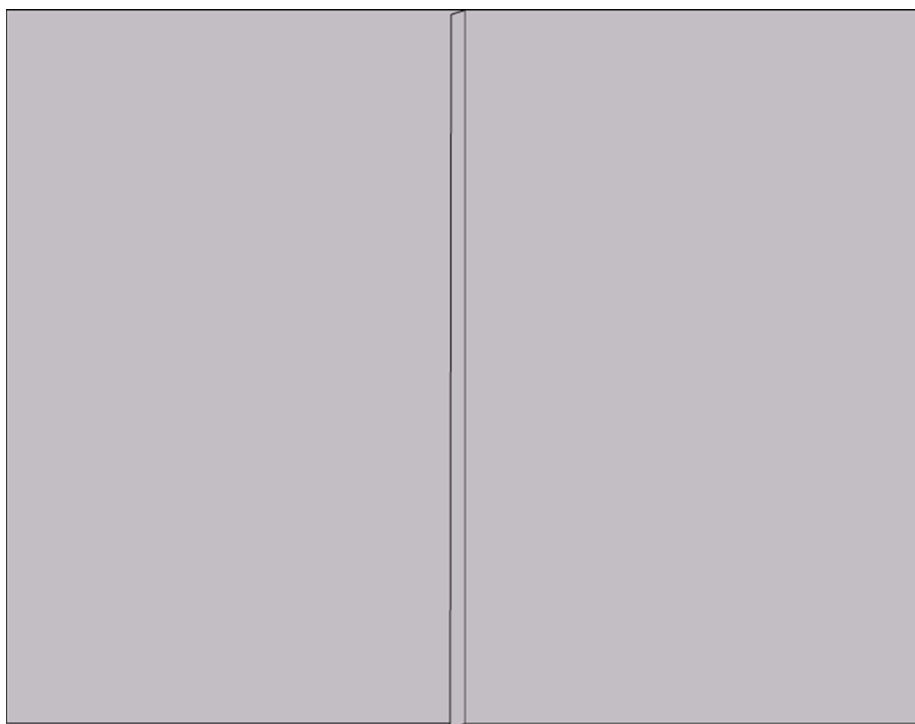

d. Corner—Use one set of 5" X 7" sample fabric. With right sides of fabric together, mark a dot at 1/2" from right edge and 1/2" from bottom as shown. Stitch at 1/2" from edge to dot, leave needle in fabric and pivot fabric swatch to stitch across the bottom at 1/2". Trim corner at a 45 angle. Turn to right side and press. Label "Corner Seam".

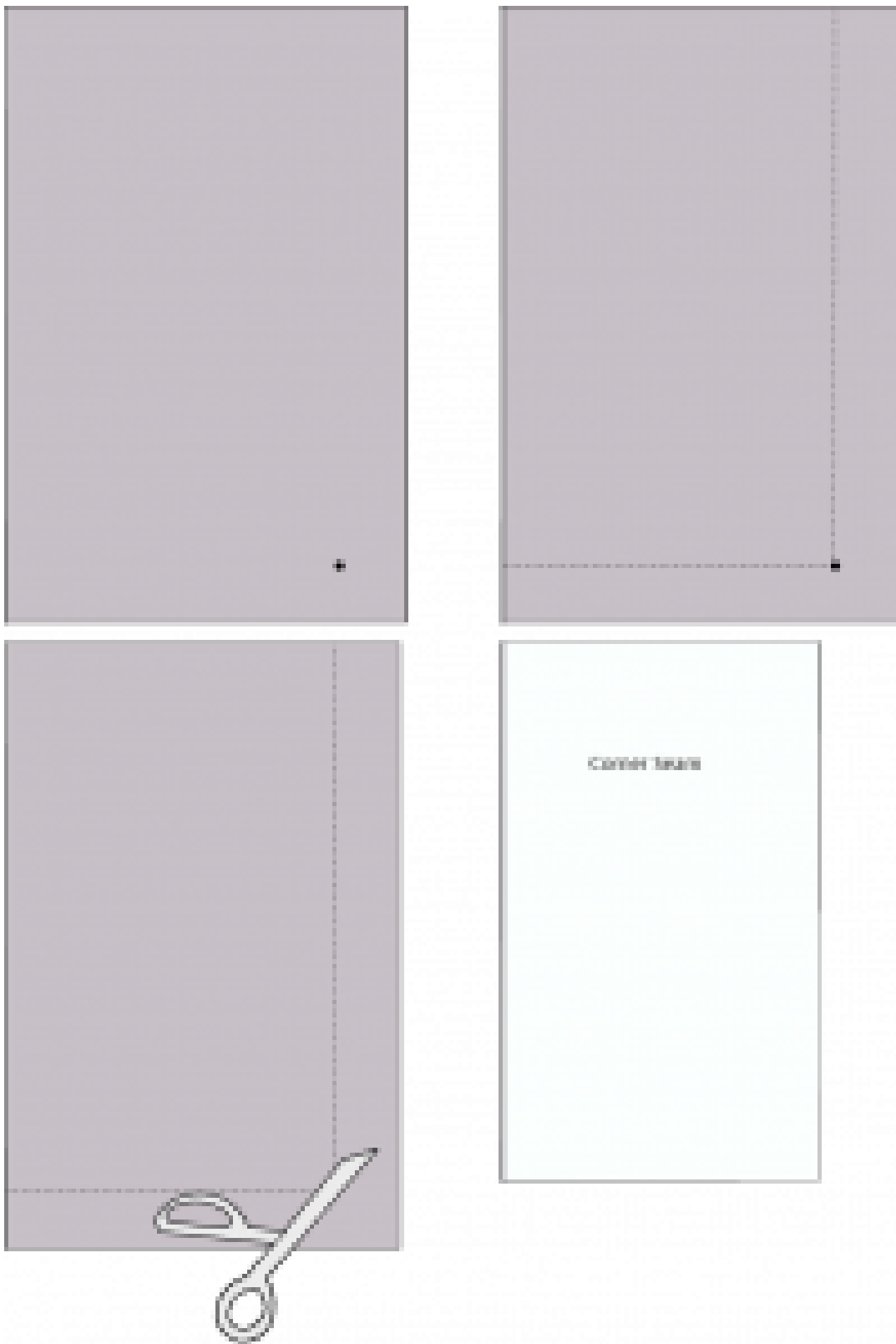

e. Curved—Use one set of 5" X 7" sample fabric. Using the template found in the back of the book, cut out the

curved sample with fabric doubled. With right sides together, stitch 1/2" on the curved side of the fabric. Clip curves and turn right side out, press. Label "Curved Seam".

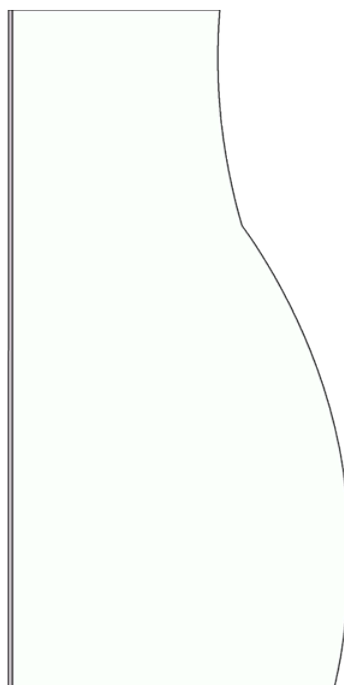
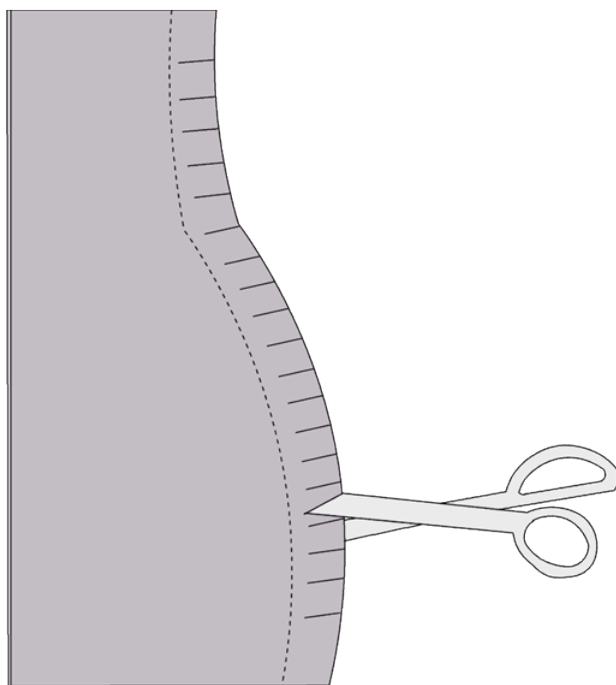
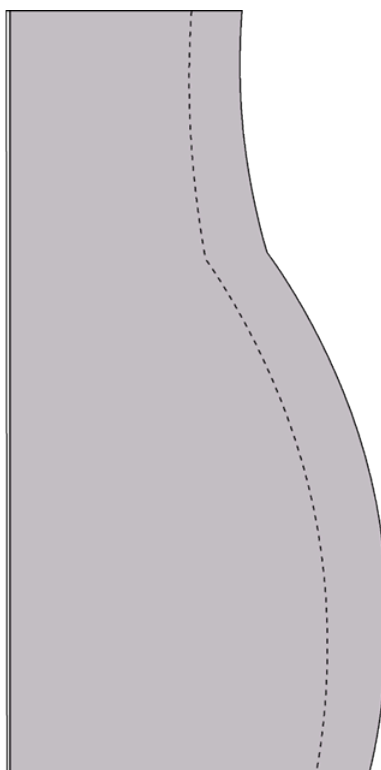
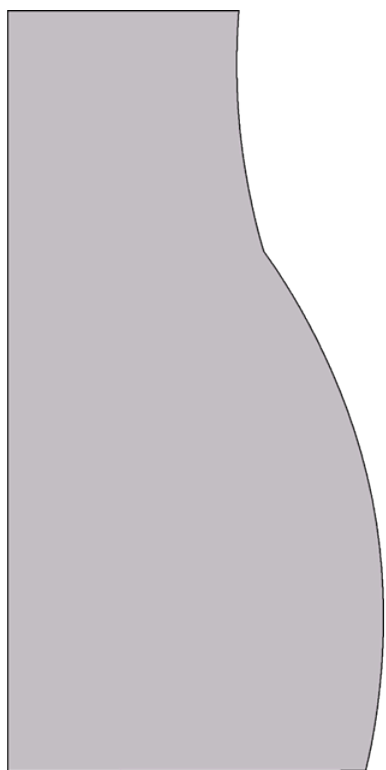



One or more interactive elements has been excluded from this version of the text. You can view them online here: <https://uark.pressbooks.pub/introapparelproductionworkbook/?p=141#oembed-1>

2. Types of Seam Finishes

a. Turned and Stitched—Use one set of 5" X 7" sample fabric. Start by repeating steps 1-3 for plain seam. Turn seam allowances under 1/4" and edgestitch (line up with outside edge of presser foot) each seam allowance. Do not stitch through to the right side of fabric.

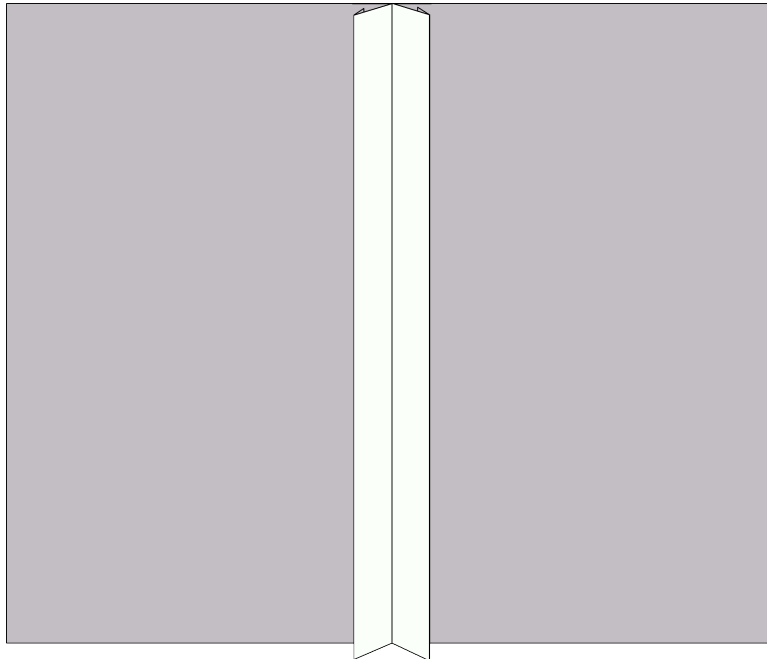

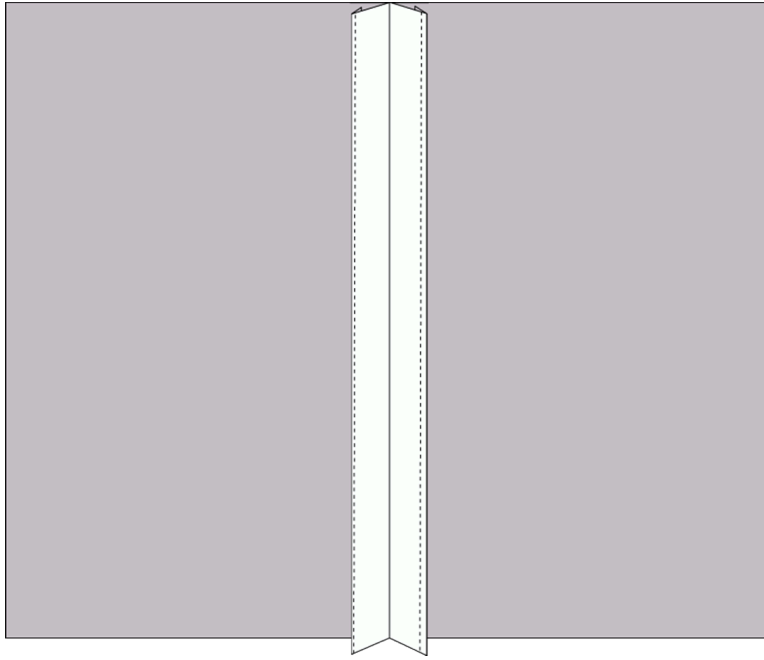

b. Stitched and Pinked—Use one set of 5" X 7" sample fabric. Start by repeating steps 1-3 for plain seam. Trim seam allowances 1/4" with pinking shears.

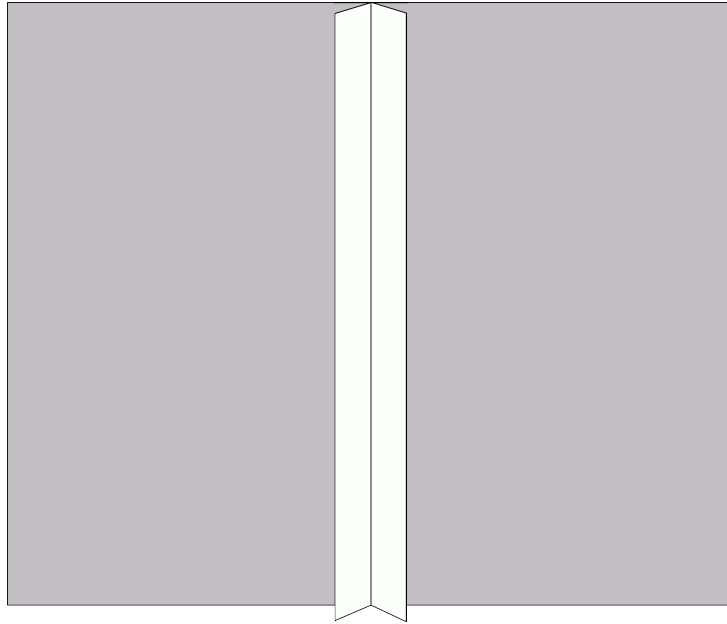

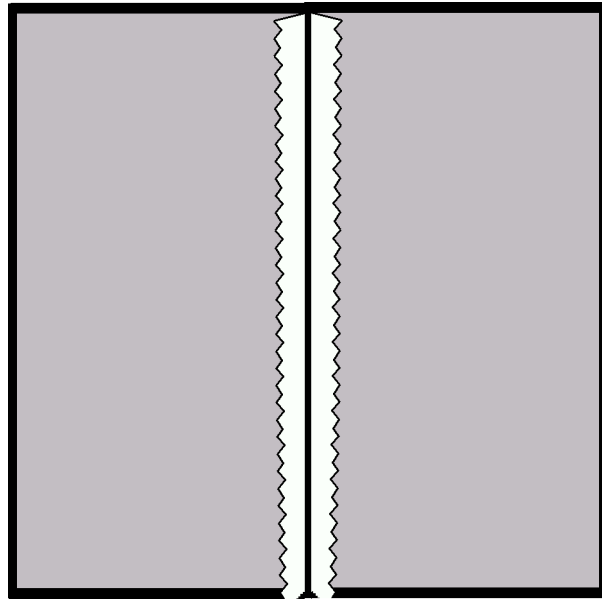

c. Hong Kong—Use one set of 5" X 7" sample fabric. Start by repeating steps 1-3 for plain seam except make seam allowances $\frac{3}{4}$ ". Using $\frac{1}{2}$ " double fold bias tape, cut 2 strips the length of the seam. One for the left and one for the right sides of the seam allowance.

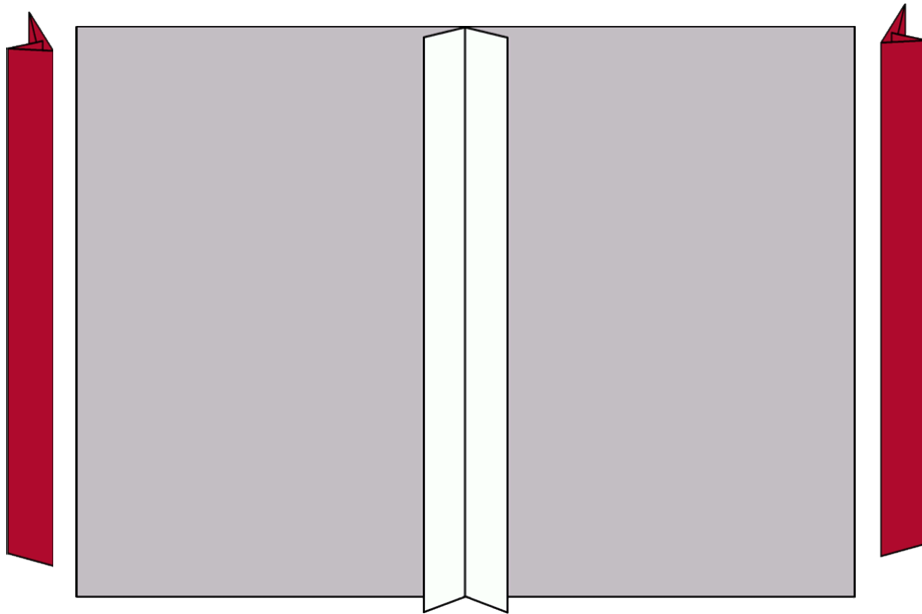

Unfold the bias tape with the sorter side on the right. Line up the edge of the unfolded bias tape to the edge of the right seam allowance.

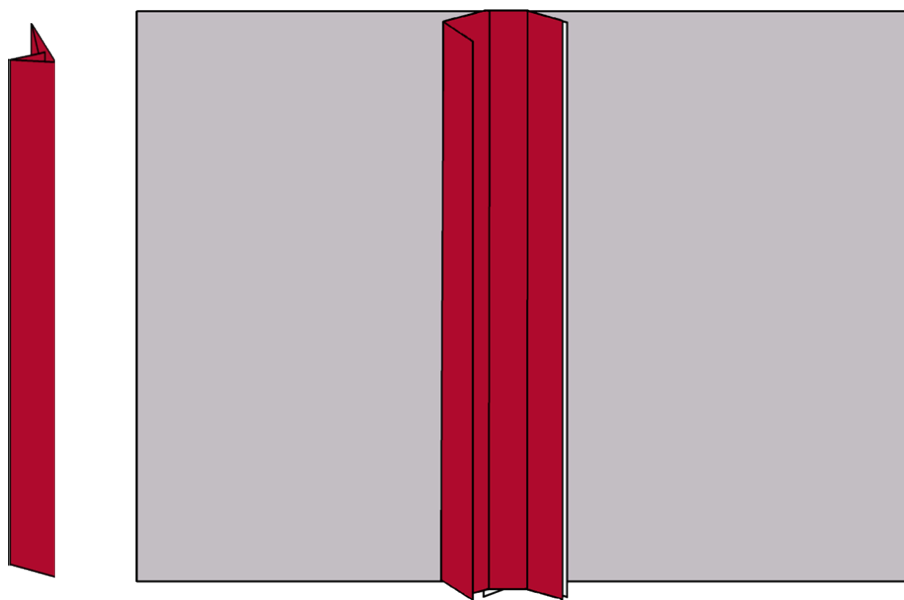

Stitch in the ditch of the fold of the bias tape to the seam allowance.

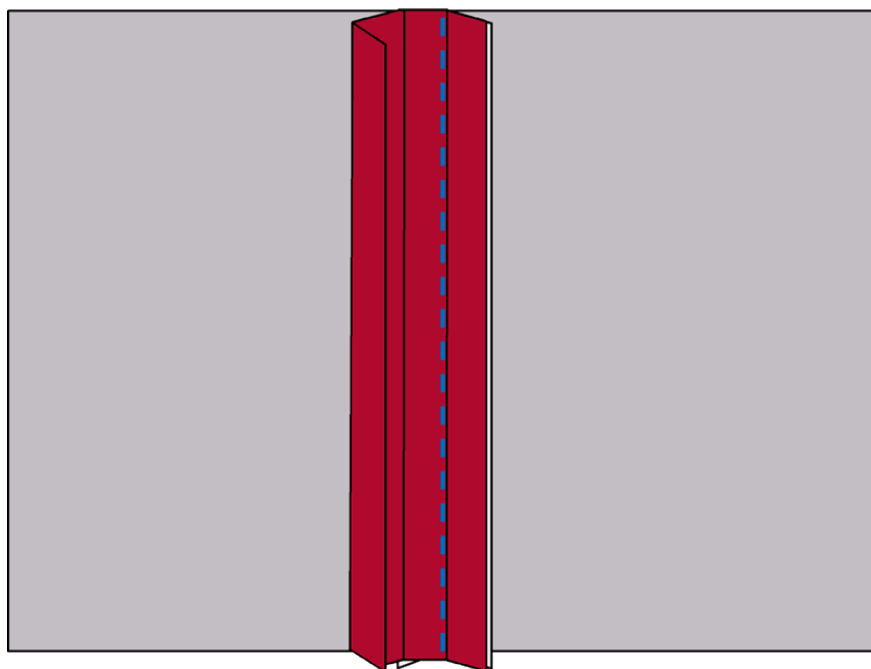

Fold bias tape to the under side of the right seam allowance as shown.

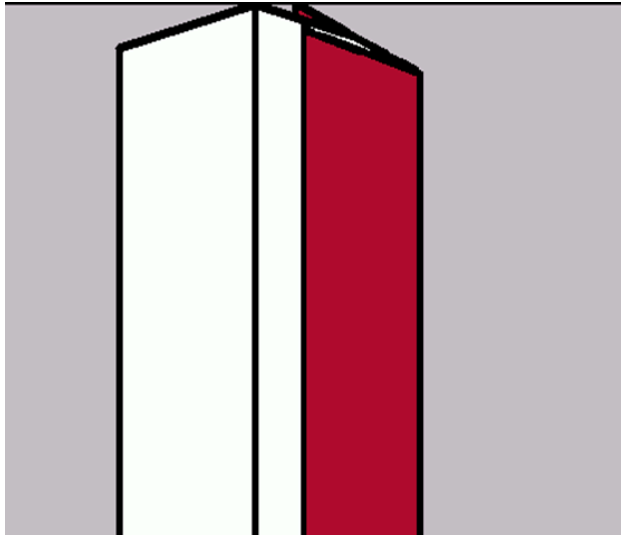

Stitch in the ditch of the seam, catching the under side of the bias tape.

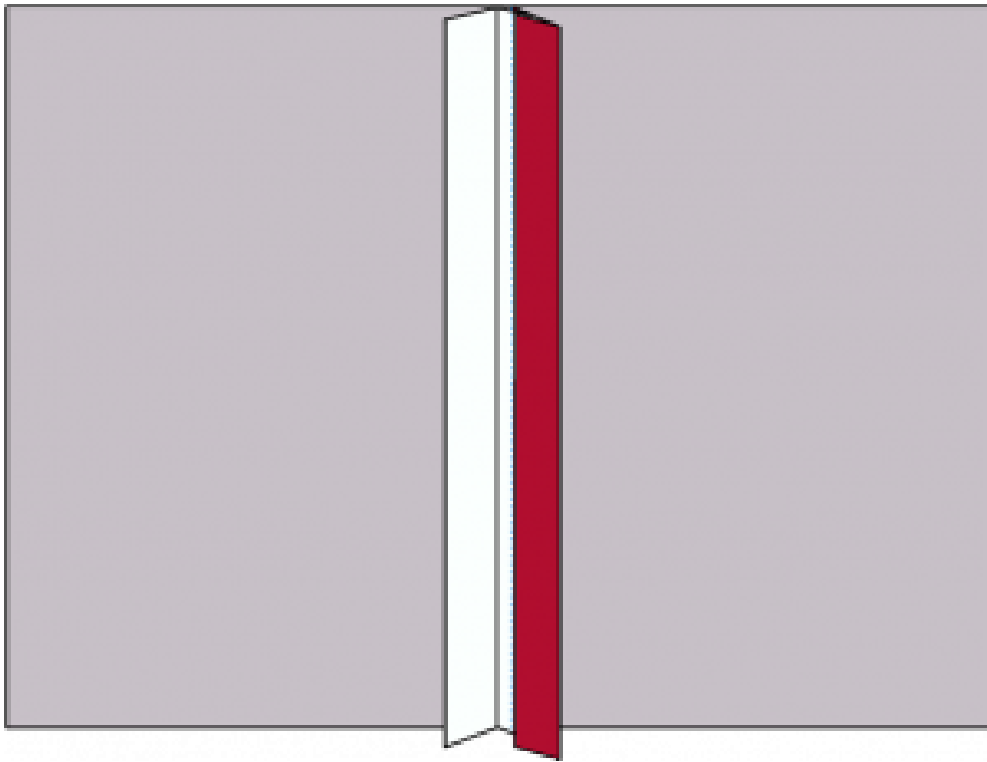

Repeat for the left side of the seam allowance. Label 'Hong Kong Finish' and place in Sample Notebook.

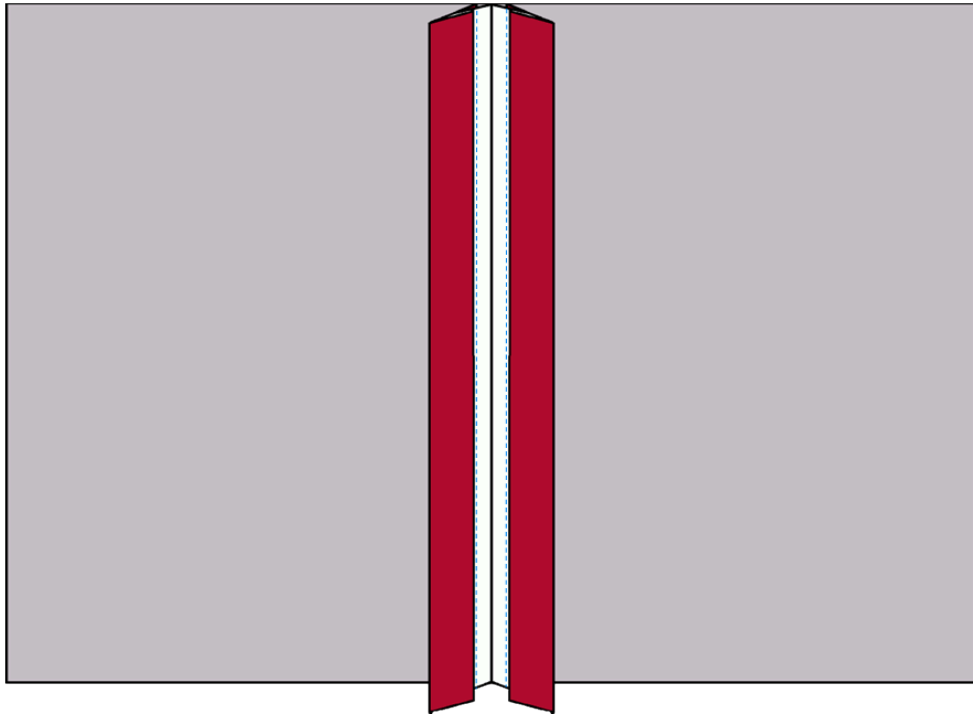

d. Serged—Use one set of 5" X 7" sample fabric. Start by repeating steps 1-3 for plain seam. Using the JUKI MO-6700 Serger, serge both seam allowances, trimming 1/8".

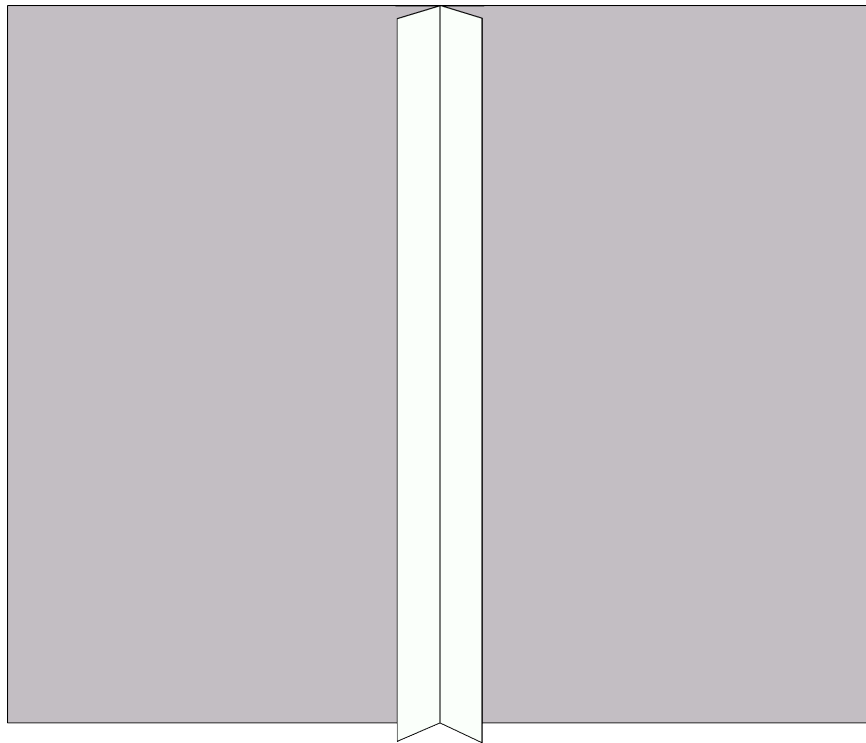

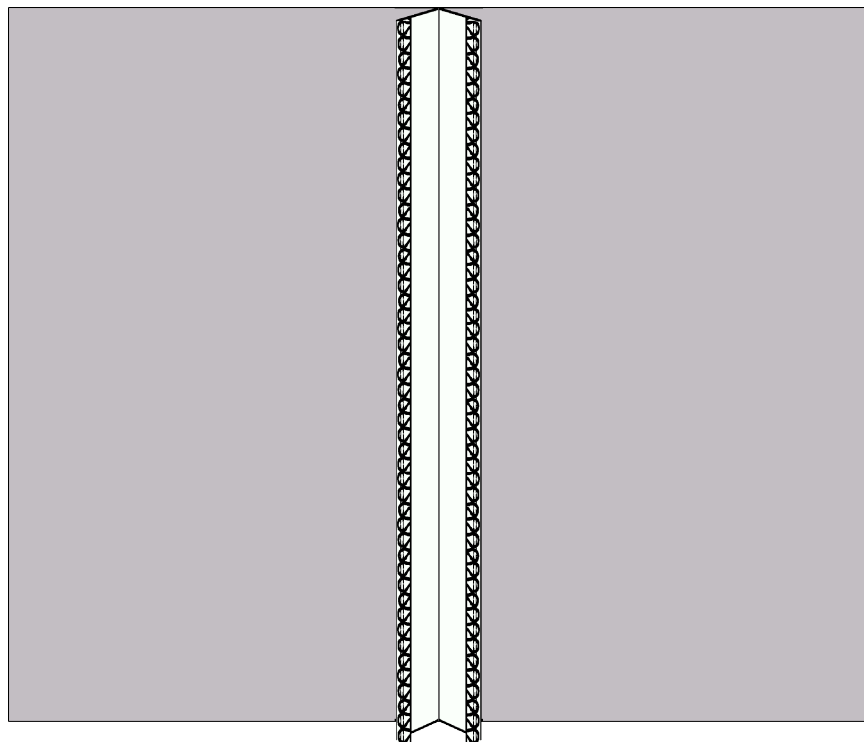

Seam Finishes Video



One or more interactive elements has been excluded from this version of the text. You can view them online here: <https://uark.pressbooks.pub/introapparelproductionworkbook/?p=141#oembed-2>

3. Stitching Techniques Prior to Garment Construction

- a. Staystitching-staystitching is used to stabilize curved seams, i.e. the neckline and armscye. Using the bodice block pattern in the appendix, cut one bodice front on fold.

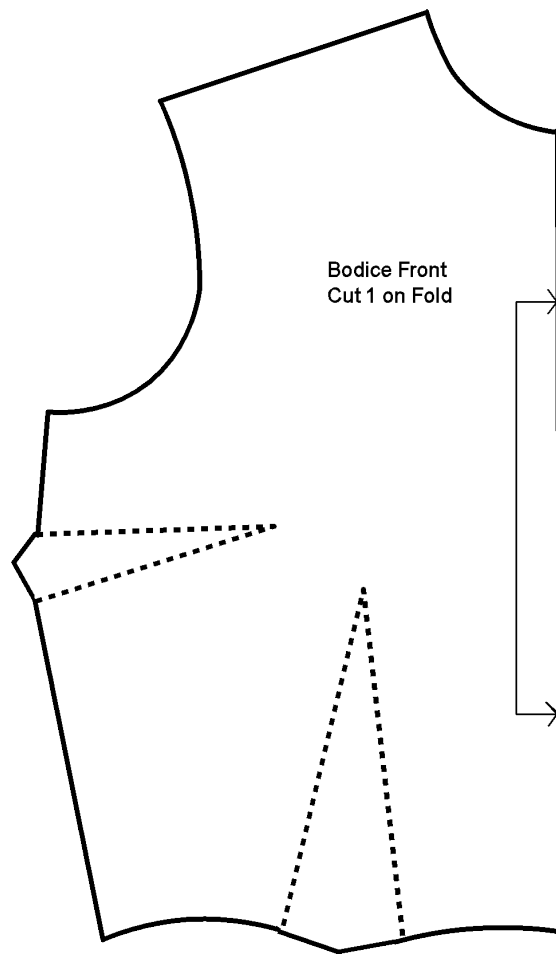

Stitch neckline and armhole at 1/2" in the direction indicated below. Label sample 'Staystitching' and place in Sample Notebook.

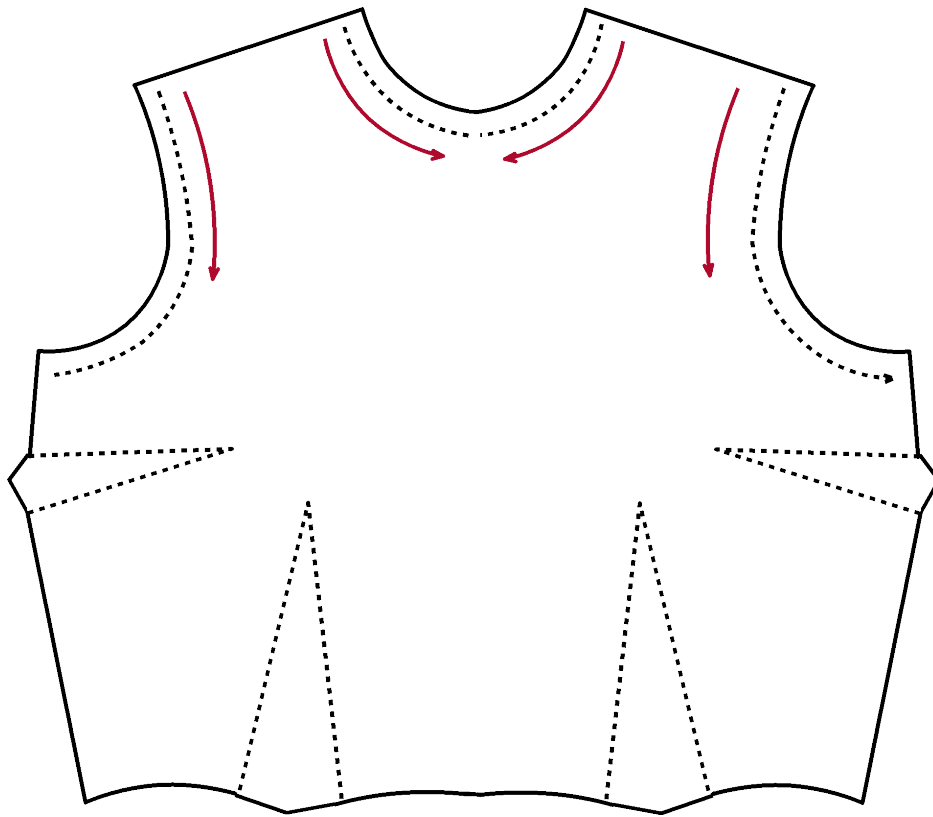

b. Darts- Darts are used to make flat fabric 3 dimensional to fit over fullness in the body, i.e. bust, hips, etc. Using Bodice front pattern in the appendix, cut one bodice front on fold. Mark the two bust darts and the two waist darts with marking pen.

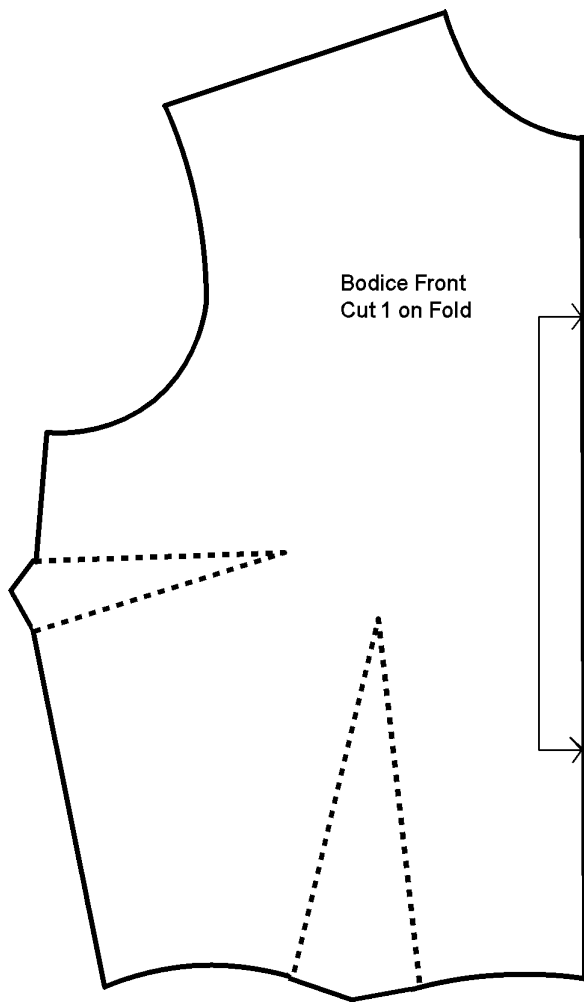

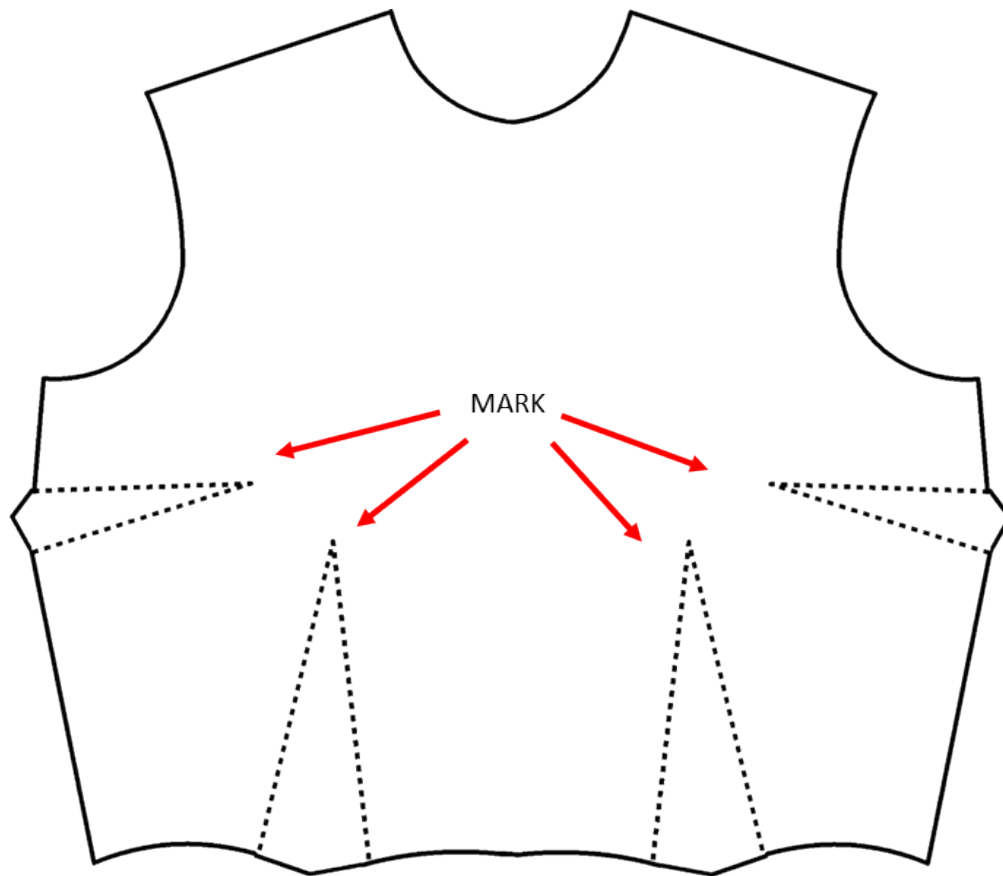

Folding toward the right side of the fabric, fold the left dart in half and secure with pins. Stitch from base of dart to apex. Press the dart toward the waist.

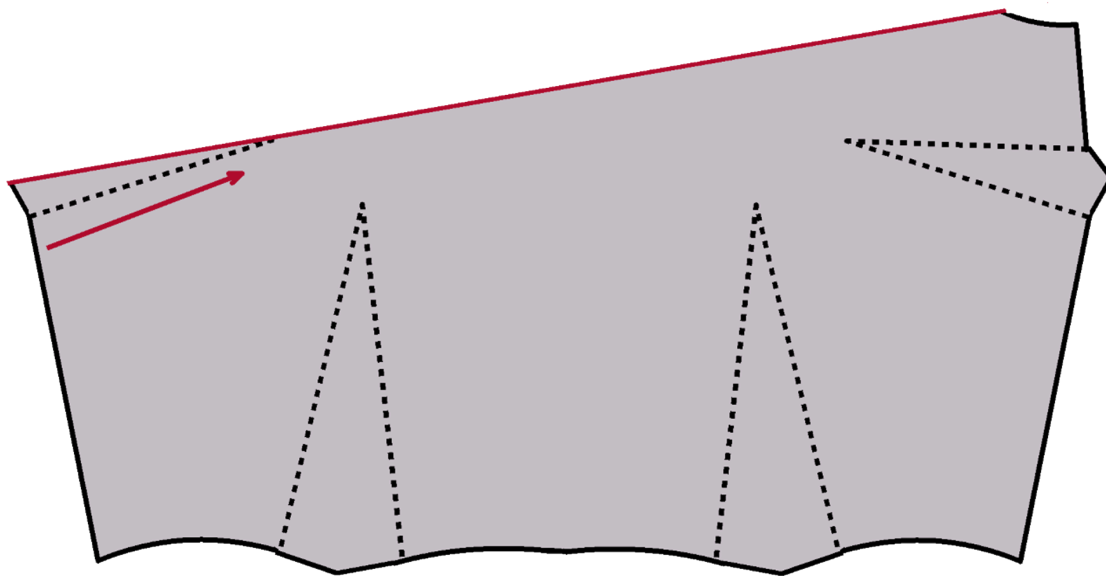

Fold the right dart in half toward the right side of the fabric and stitch from base to apex.

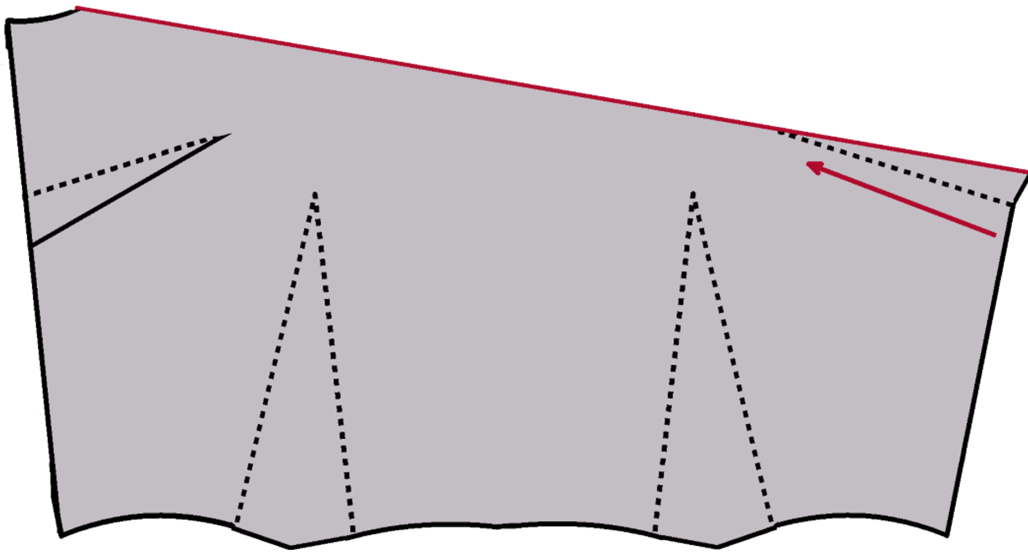

Fold the left waist dart in half and stitch from base to apex. Repeat for right dart.

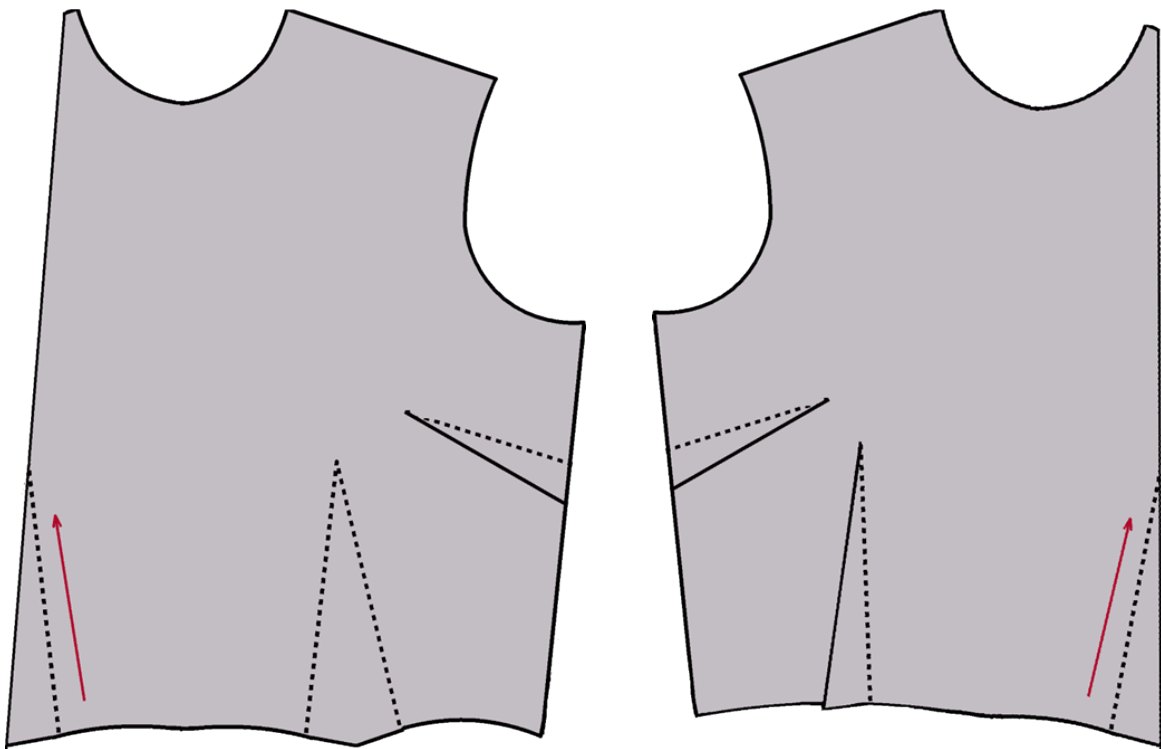

Label bust and waist darts. Place sample in Sample Notebook.

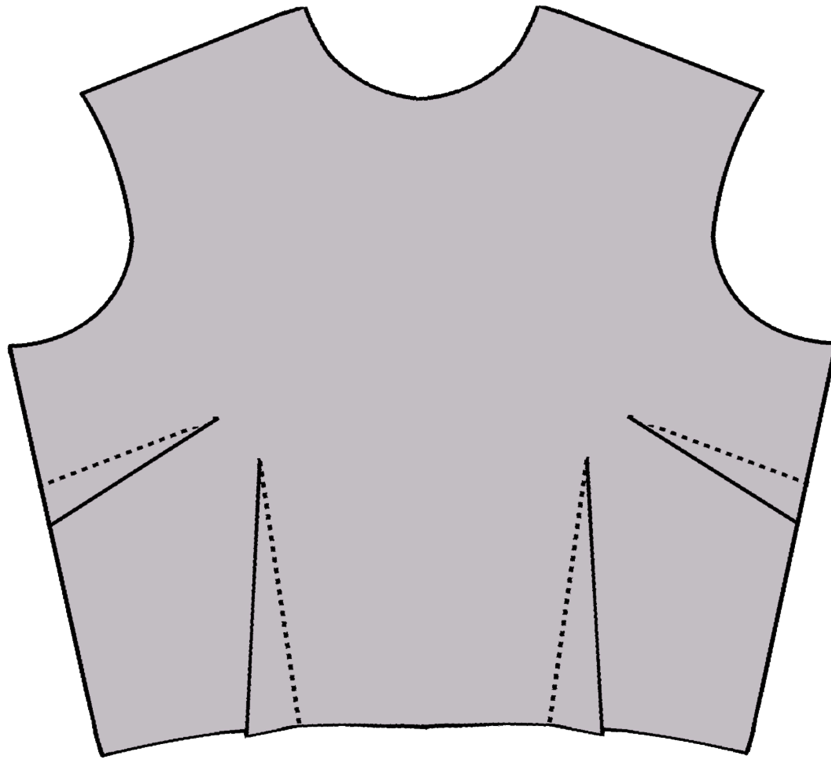

Finished darts from the wrong side.

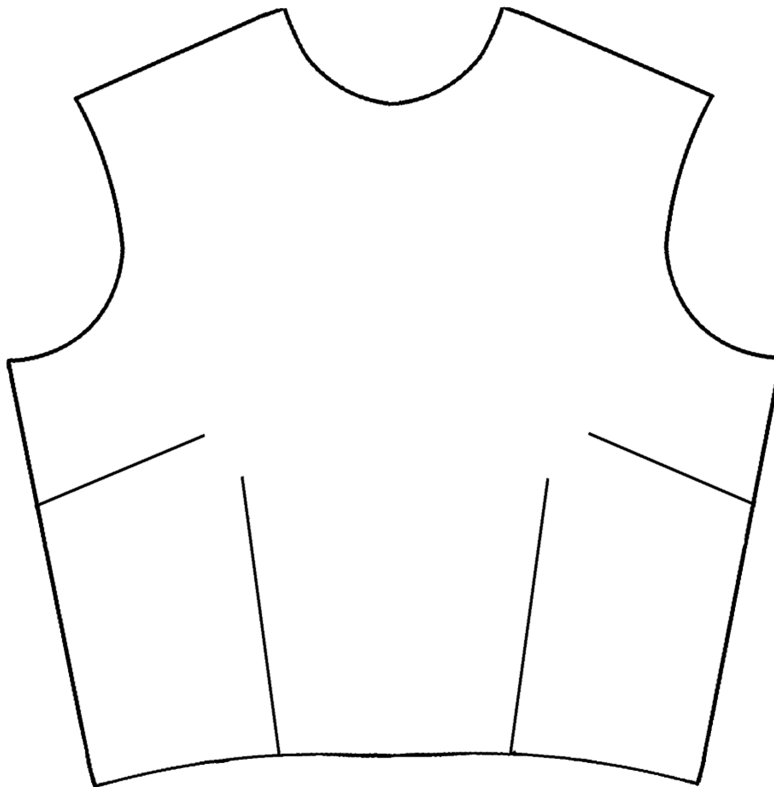

Finished darts from the right side.

c. Easing-Easing is used to force fullness of one fabric into a smaller area without causing ripples, gathering or pleating. For this class, easing will be used to place a sleeve cap (as shown below) into the armscye of a shirt.

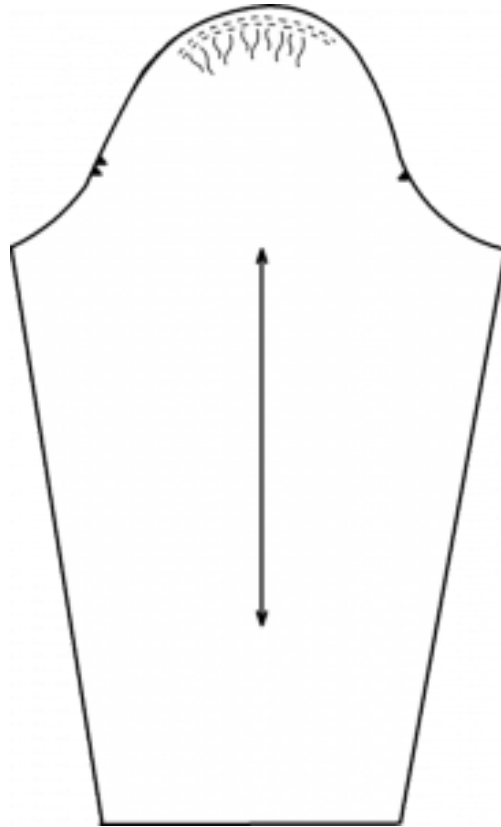

For the easing sample, using the pattern provided for easing in the appendix, cut one of each pattern A and B. Using a basting stitch of 5, stitch 2 rows at 1/4" and 3/4". Leave 4" tails of thread on each end of stitching. Do not back tack.

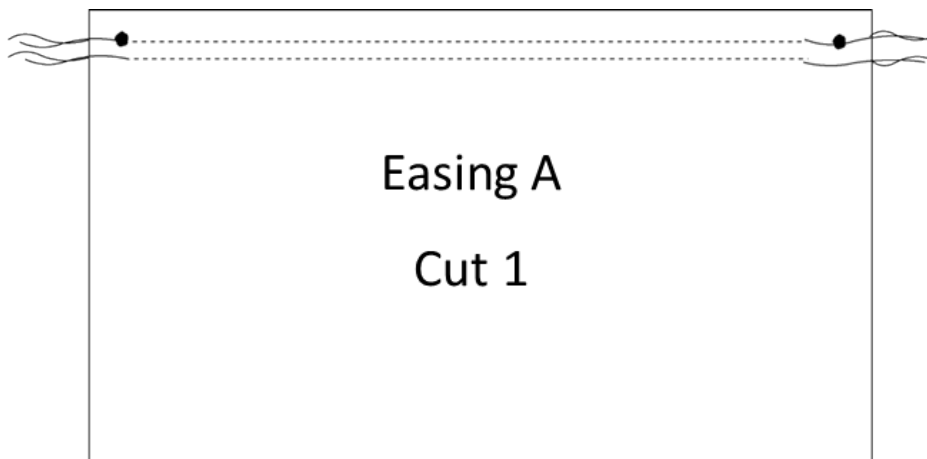

Easing B

Cut 1

Videos of Pre Stitching Techniques prior to Garment Construction



One or more interactive elements has been excluded from this version of the text. You can view them online here: <https://uark.pressbooks.pub/introapparelproductionworkbook/?p=141#oembed-3>

4. Stitching Techniques after Garment Construction

- a. Trimming- trmming is used to remove bulk form both seam allowances.

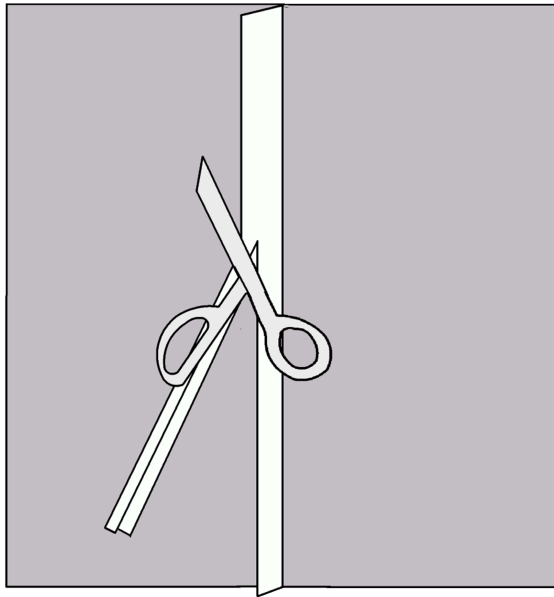

- b. Grading- grading is trimming only one side of the seam allowance.

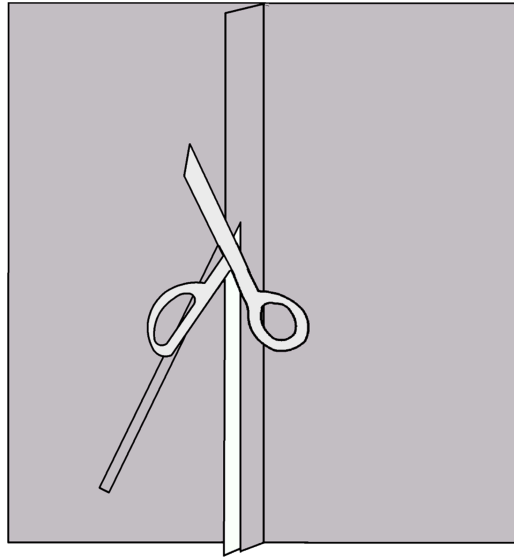

c. Edge Stitching/Understitching- is used to help keep seam allowance or facing in place. It is also used as a decorative stitch on the face of the fabric. It is stitched on the right side of the fabric next to the seam allowance following the inside edge of the presser foot.

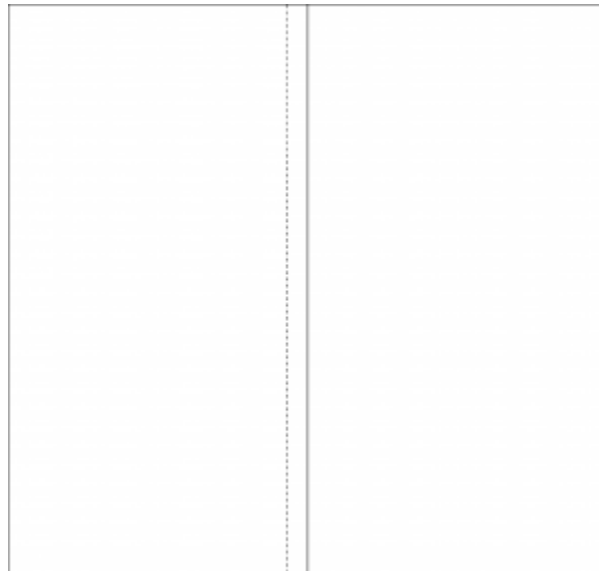

d. Topstitching – is used as a decorative stitch on the face of the fabric. It also adds strength and support to seams. It is stitched at 1/2" from the seam.

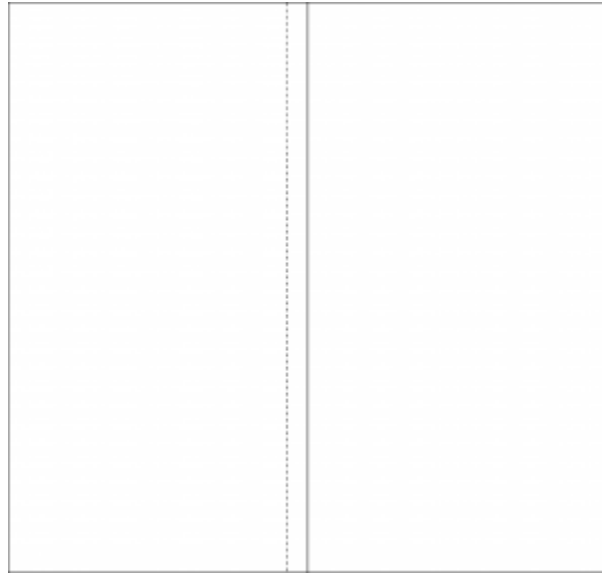

e. Clipping—clipping is used on concave curved seams to remove bulk. Using the pattern in the appendix for clipping, cut 2. With right sides together, stitch $\frac{1}{2}$ " seam from concave side of sample. Make small slits in the seam allowance around the curve approximately $\frac{1}{2}$ " apart.

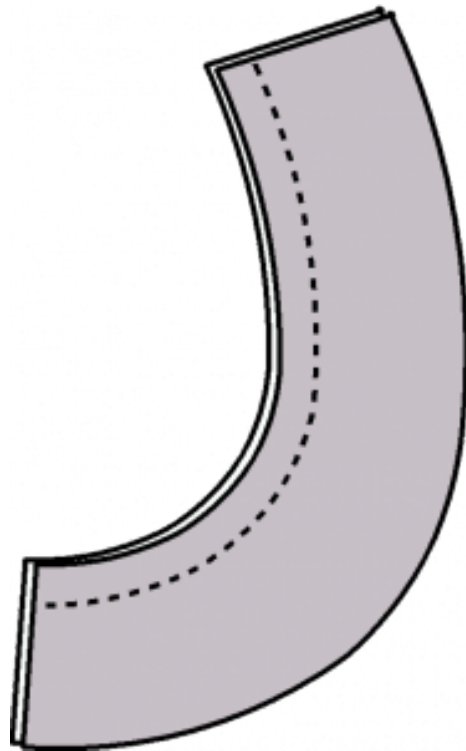

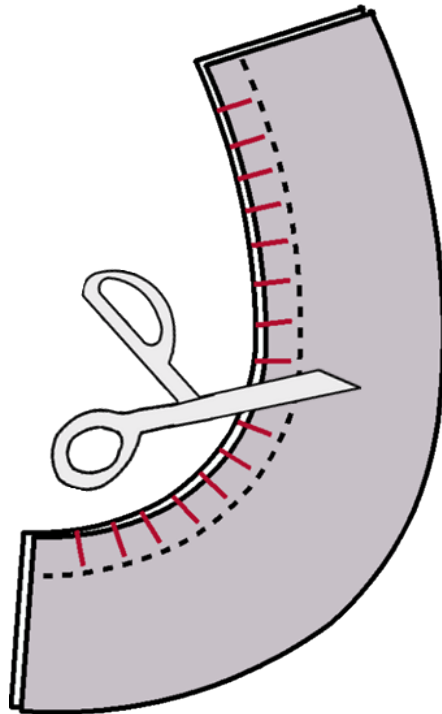

f. Notching—is used on convex curved seams to remove bulk. Using the pattern in the appendix for notching, cut 2 out so sample fabric. With right sides together, stitch 1/2" seam from the convex side of sample. Make small notches in the seam allowance around the curve approximately 1/2" apart.

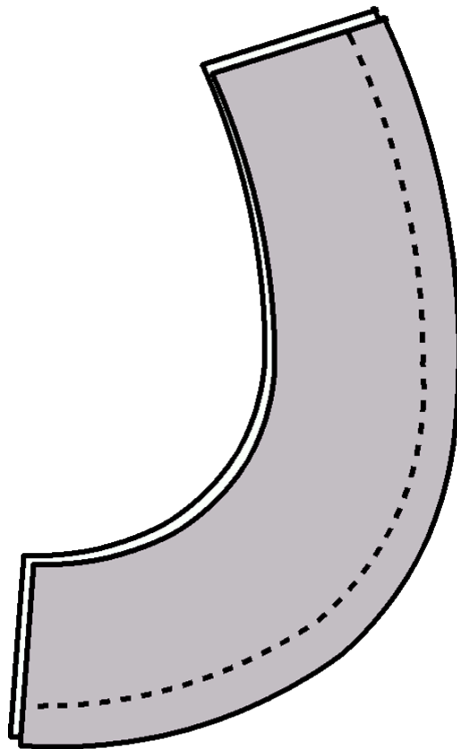

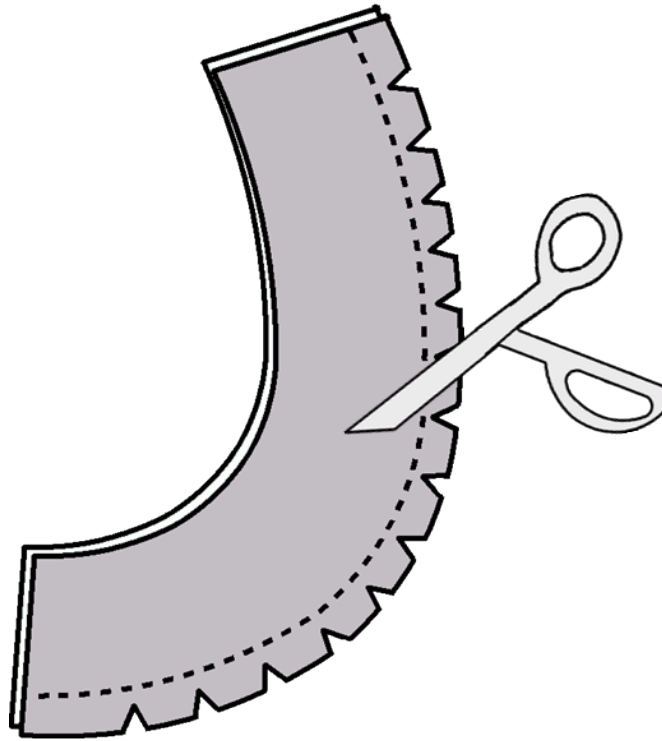

5. Hand Stitches

a. Catch Stitch -is used to hand sew hems and facings. It is a series of small X's. The needle direction is from right to left, but you are stitching from left to right. See steps below. Label as "Catch Stitch" and place in Sample Notebook.

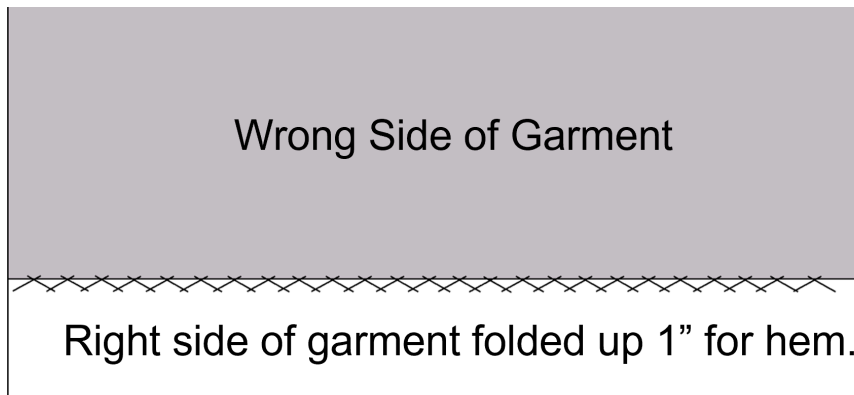

Step 1. Using a single thread with a knot in the end, begin the stitch on the hme side of the fabric taking just a few threads.

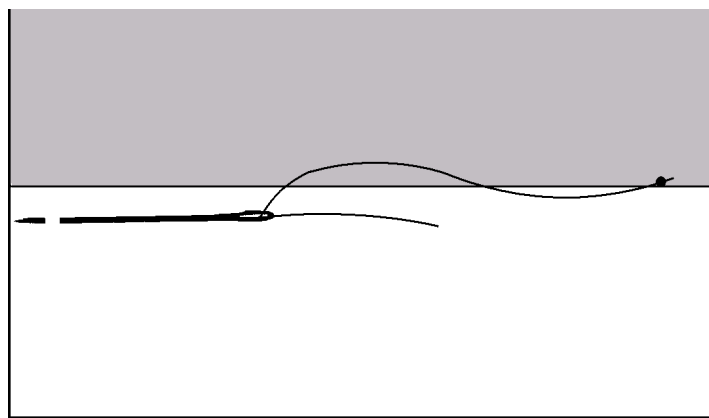

Step 2. Pull thread through to the knot and begin the next stitch on the garment just above the folded hem edge.

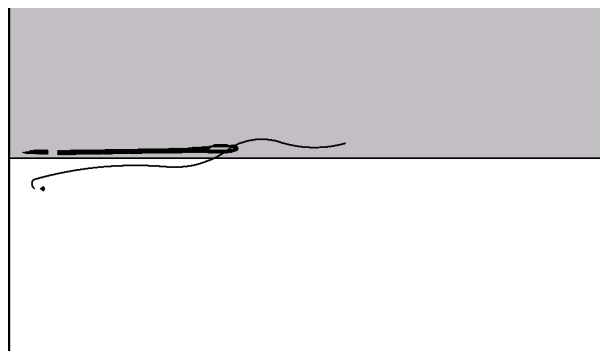

Step 3. Pull thread to just taut and begin the next stitch on the hem about 1/2" from the first stitch.

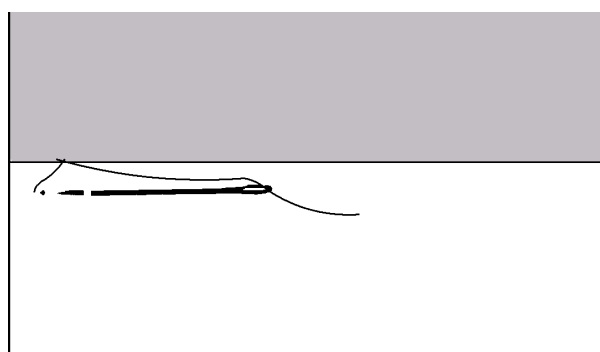

Step 4. Repeat to the garment and alternate back and forth from the garment to hem until you reach the end. Secure the thread by stitching in the same place several times.

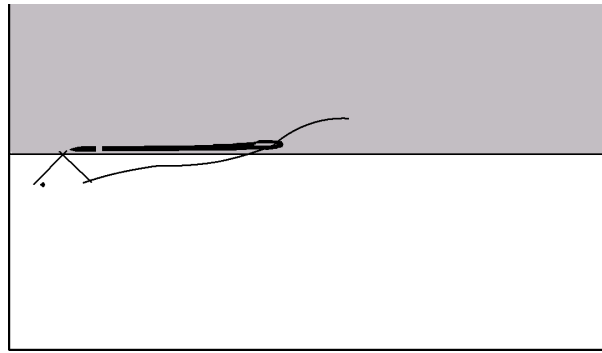

b. Blind Catch Stitch -The blind catch stitch is the same stitch as the catch stitch with one exception, the top of the hem is folded down so the stitches occur between the garment and the hem. This allows for the catch stitch to be hidden once the fold is pressed up.

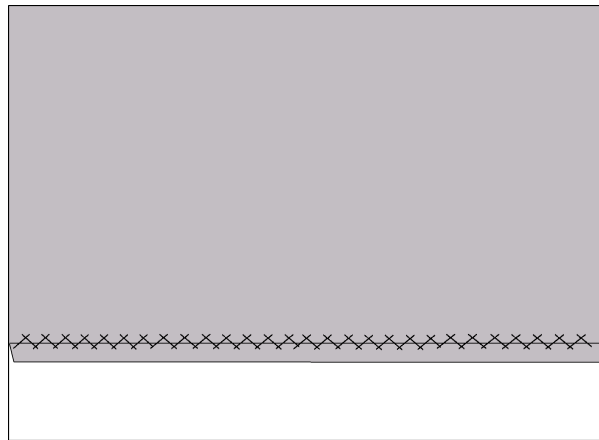

View after the fold in the top of the gem has been pressed up. You should only see the small stitches. Label "Blind Catch Stitch" and place in Sample Notebook.

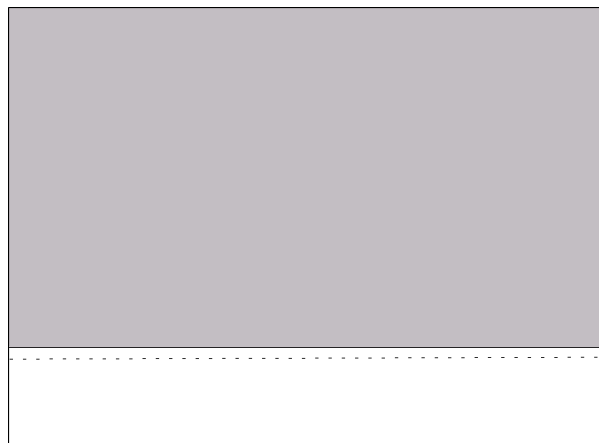

c. Slip Stitch – The slip stitch is a hidden stitch. It is stitched into a fold (or channel). For this sample, you will fold the edge up 1/4" then press, fold again at 1" and press.

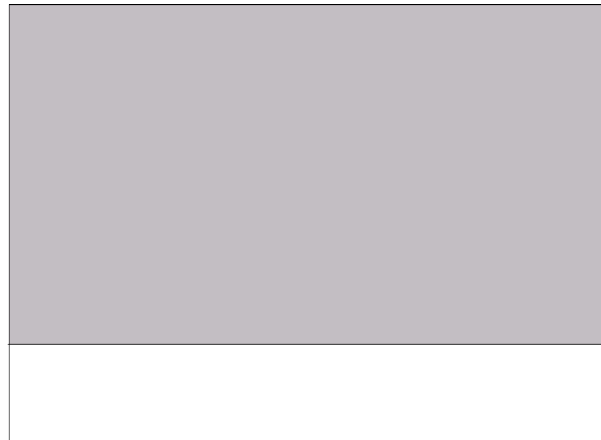
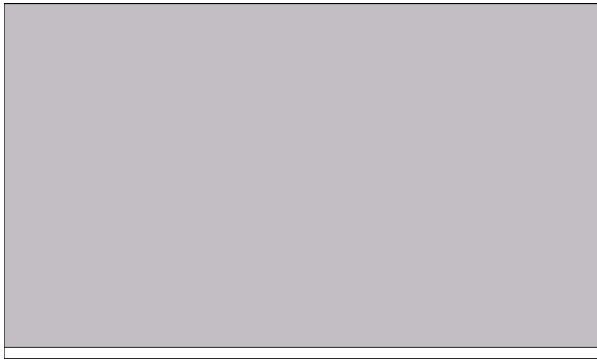

Close up view of folded edge.

Start by threading a sewing needle with a single thread and knot at the end.
Step 1. Insert needle into fold of hem, run the needle in the fold about 1/4".

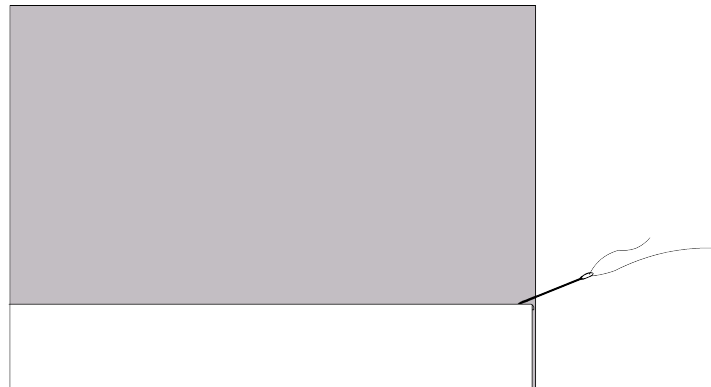

Step 2. Bring needle up through the fold.

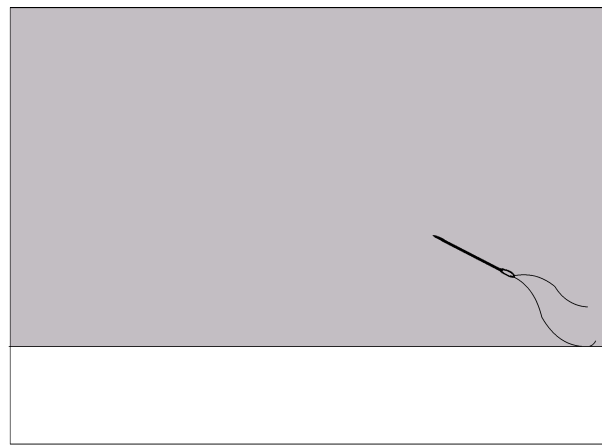

Step 3. Insert needle directly above the fold on the garment and catch a few threads of garment.

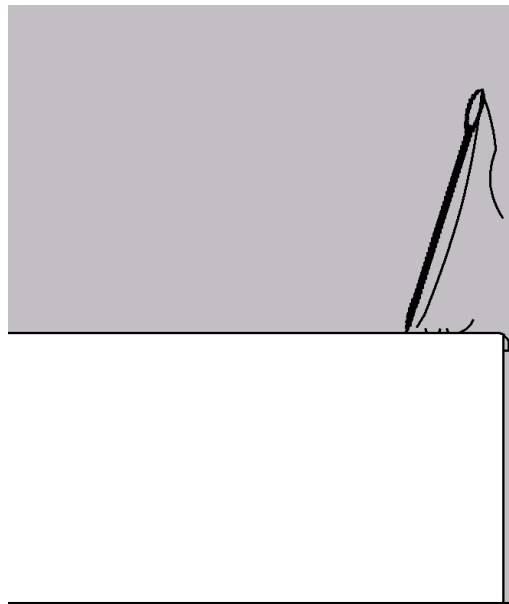

Step 4. Insert needle back into the fold of the hem directly below the stitch of the garment.

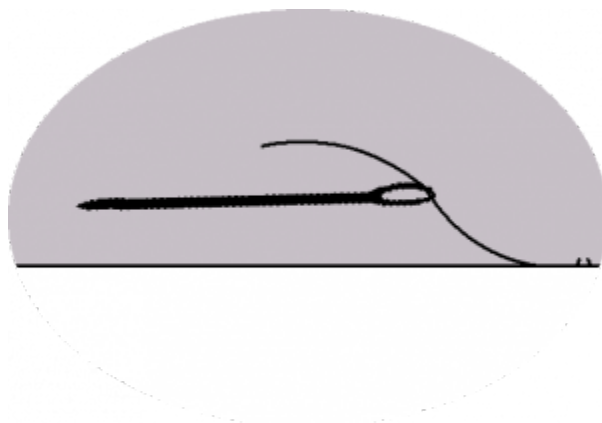

6. Closures: Zippers

A. Invisible Zipper – an invisible zipper is used in a seam line to hide the zipper from being seen from the outside of the fabric. Cut a set of 5" by 12" rectangles from the sample fabric on-grain. Serge the long edge on both pieces with right sides of fabric facing up.

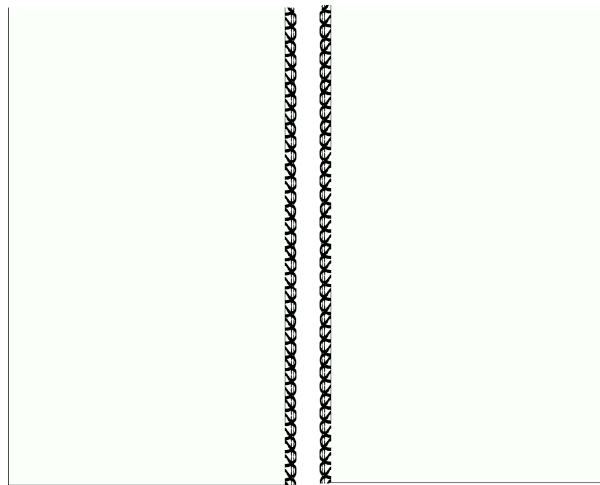

Unzip the invisible zipper and turn over to wrong side. Using just the left sample piece, place the right zipper tape on the seam line of the left sample.

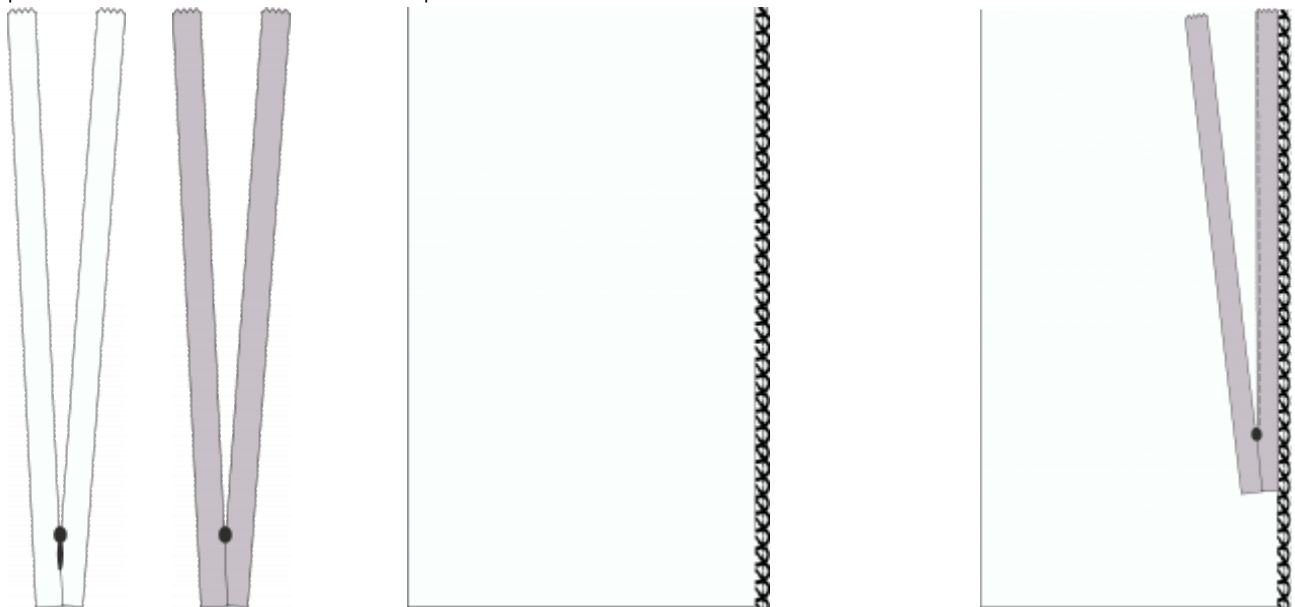

Uncoil the zipper teeth to the left, there will be a ditch (fold) seen. Using the invisible zipper foot, place the uncoiled zipper teeth in the left groove of the zipper foot and stitch down to the head of the zipper and back tack.

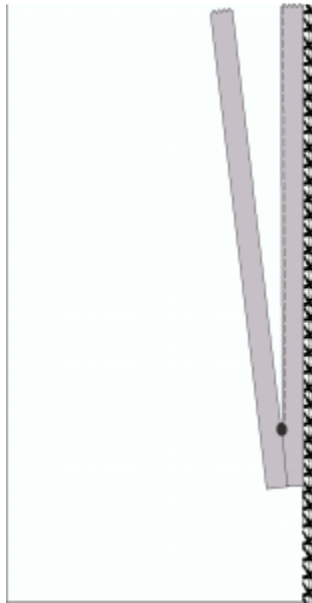

Turn the zipper to the right side by flipping to the right. You should be able to zip the zipper all the way to the top. If you cannot zip to the top, you may have caught the zipper teeth in your stitching and will need to remove and restitch. Next, flip the entire sample and zipper upside down.

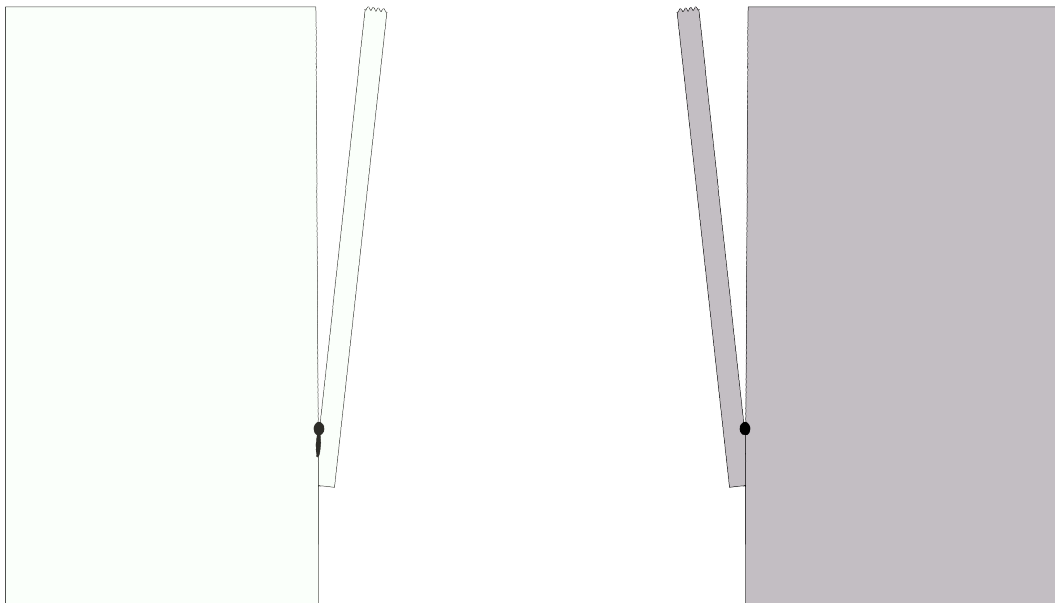

Place the zipper on the right serged edge of the sample piece. Uncoil the zipper teeth to the right and place in the right groove of the zipper foot and stitch in the ditch.

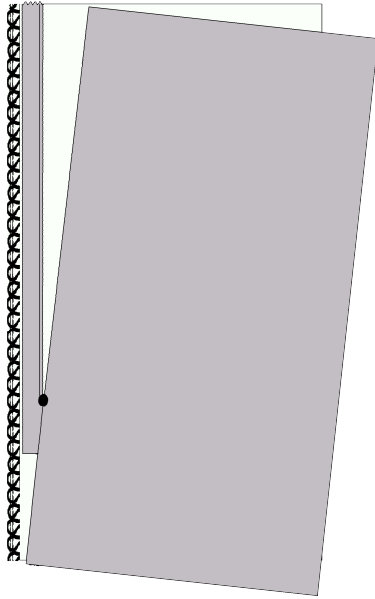

Complete the seam below the zipper by placing right sides of fabric together. Begin stitching where the zipper stitching ended and stitch to the bottom of the sample.

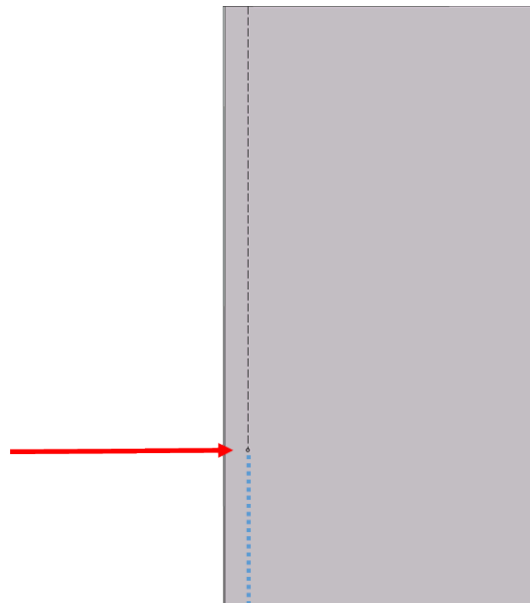

B. Lapped Zipper – this zipper is hidden by a lap of fabric that folds over the zipper and is a common zipper to use for side seam zipper openings.



1. Cut a set of 5" by 12" sample fabric.

2. With right sides together, lay the zipper on the edge and mark the end of the zipper stop on the fabric with a marking pen or straight pin.



3. Using a stitch length of 5, stitch a basting stitch from the top edge to the mark. Leave your needle in place and change your stitch length to 2.3-3, back tack and continue stitching to the bottom of the fabric sample.



4. Press the seam open.

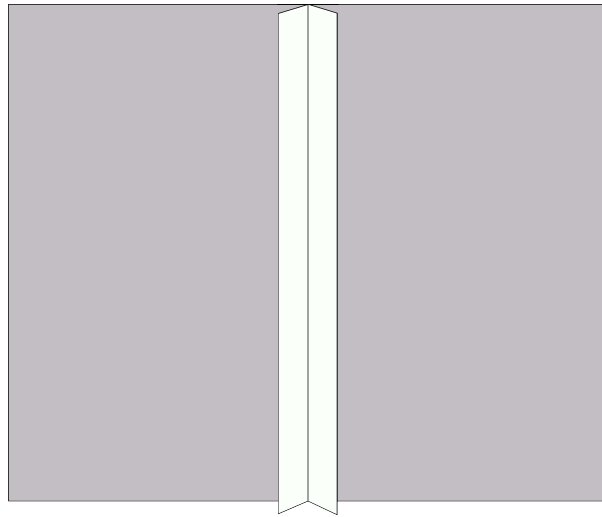

5. Move the right side of the sample fabric under the left side with only the seam allowance on the right edge.

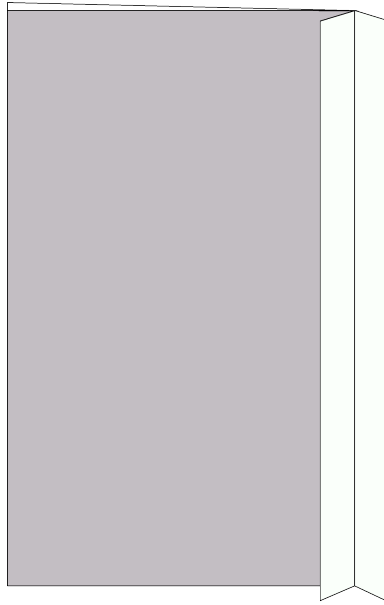

6. Place the zipper face down on the right side of the seam allowance with zipper teeth on the seam line. Pin in place.

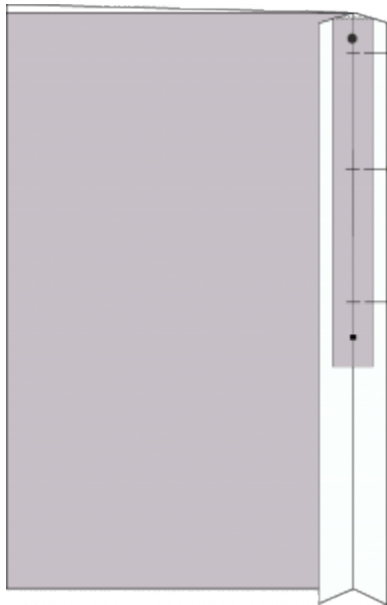

7. Using the notched zipper foot, stitch from the top edge of the zipper to the bottom of zipper.

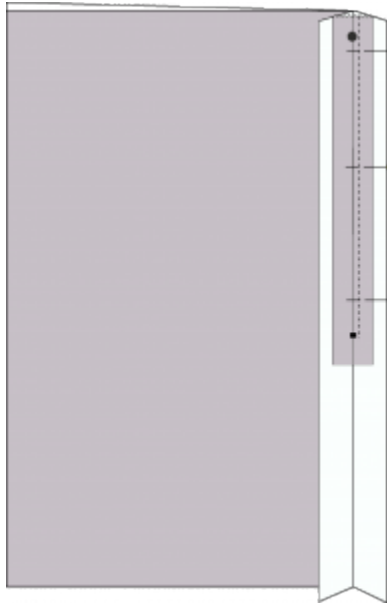

8. Fold the zipper to the right so that the right side is showing. The fold should be on the right seam allowance. Edge stitch on the fold of the seam allowance.

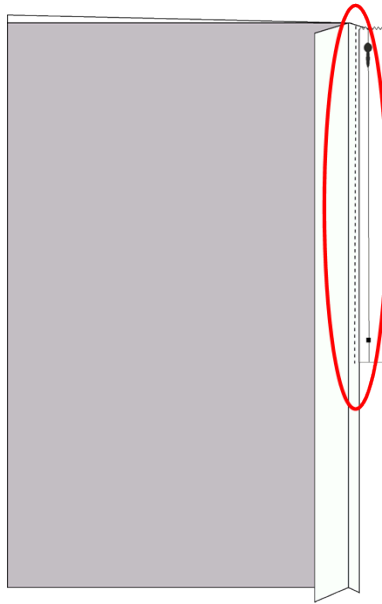

9. Unfold your sample with right sides up. You will not be able to see the zipper, but make sure the zipper is laying right side up under the sample. If you could see through the right side, it should look like the right yellow shaded area.

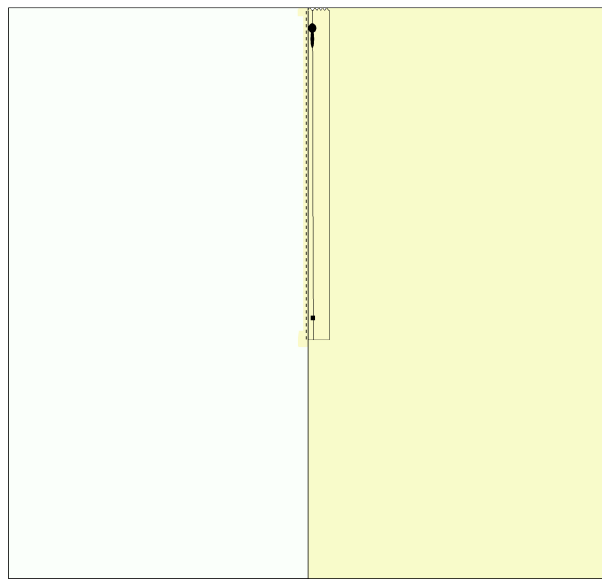

10. Use a needle and thread and hand baste from just above the metal zipper to the top edge of the sample.

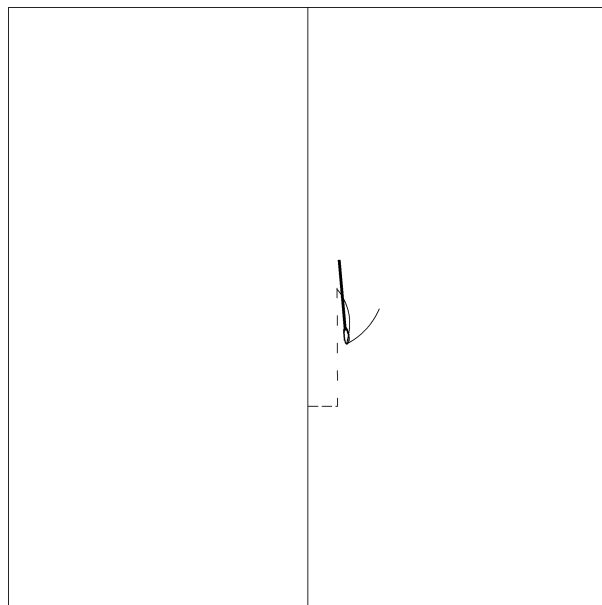

11. Machine stitch (BLUE) the zipper following the basting lines.

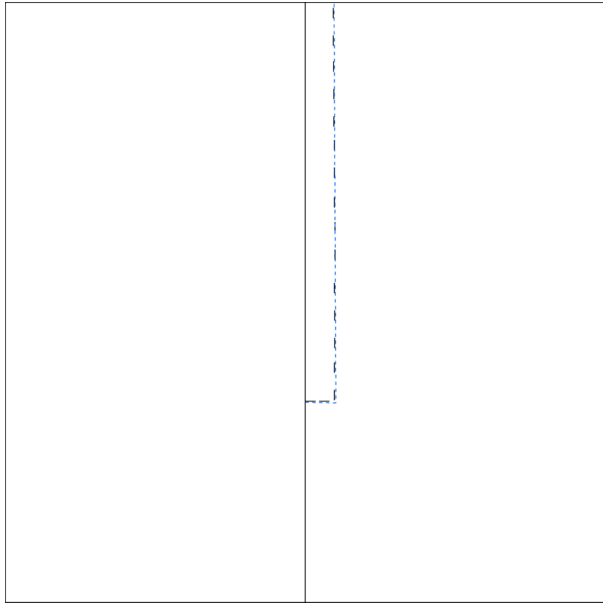

12. Remove the basting thread.

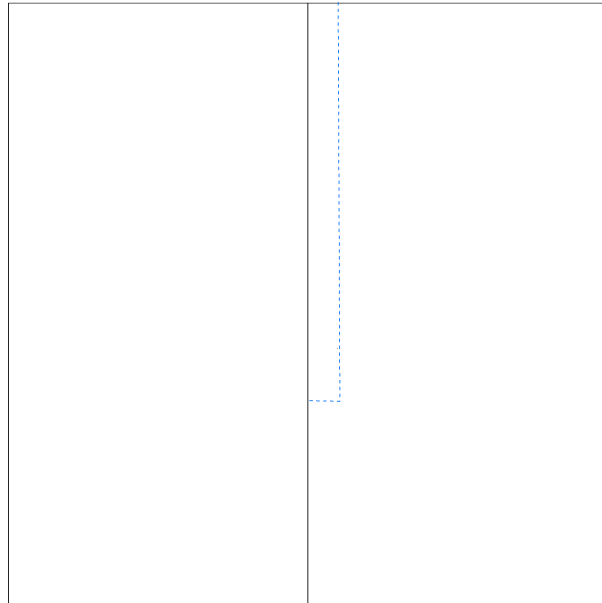

13. Gentle open the seam and remove the basting thread from the seam to expose and open the zipper all the way to the zipper stop. Label "Lapped Zipper" and place in the Sample Notebook.

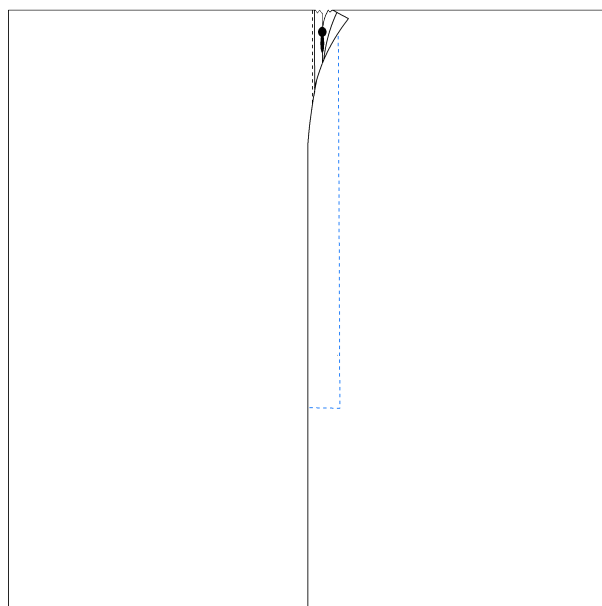

C. Centered Zipper-this zipper is hidden by a 2 laps of fabric that meet over the center of the zipper teeth.
Step 1. Cut a set of 5" by 12" sample fabric.



2. With right sides together, lay the zipper on the edge and mark the end of the zipper stop on the fabric with a marking pen or straight pin.

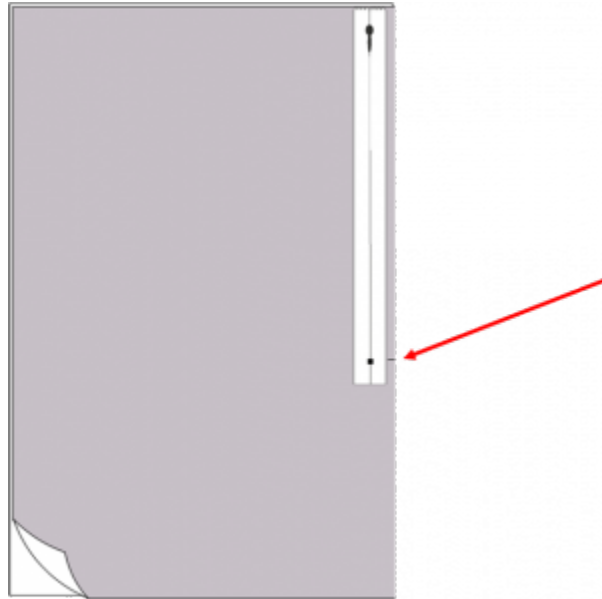

3. Using a stitch length of 5, stitch a basting stitch from the top edge to the mark. Leave your needle in place and change your stitch length to 2.3-3, back tack and continue stitching to the bottom of the fabric sample.



4. Press the seam open.

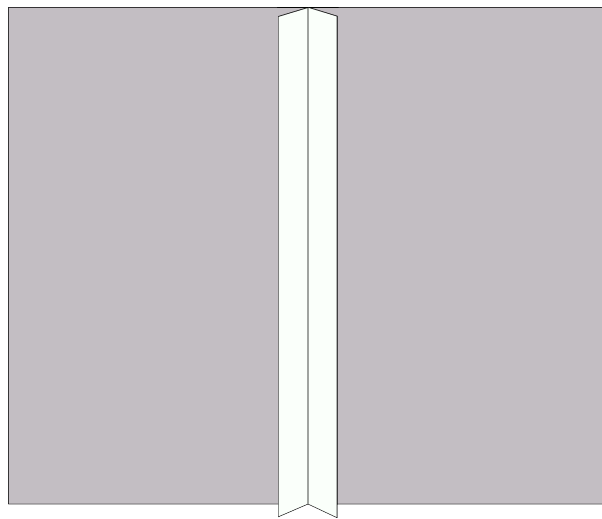

5. Unzip the zipper and turn it face down. Take the left side of the zipper tape and place on the left seam allowance. Pin in place.

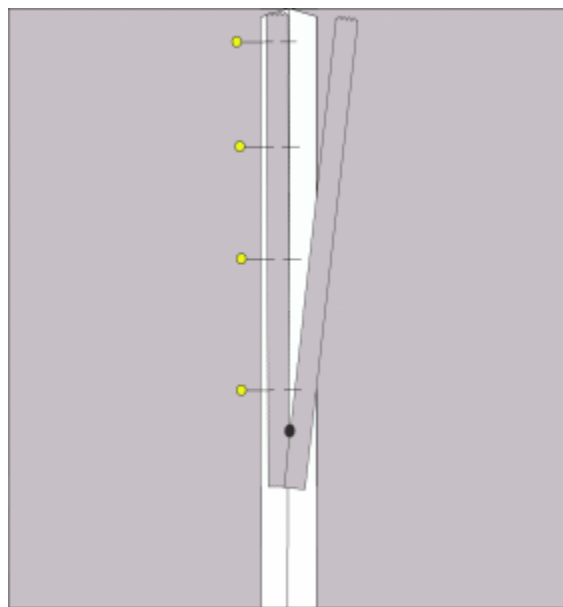

6. Hand baste the zipper tape in place to the seam allowance only.

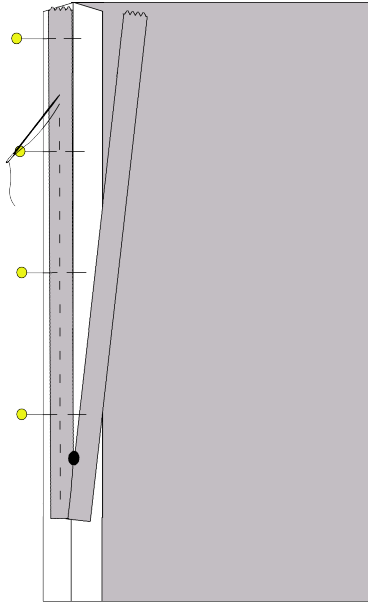

7. Using the notched zipper foot, stitch the zipper tape to the seam allowance. Remove basting stitch.

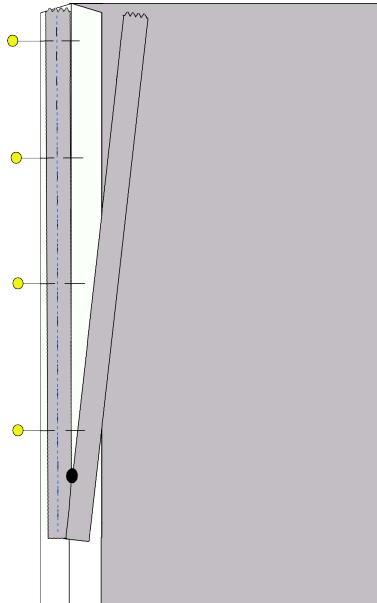

8. Close the zipper and pin the right zipper tape to the right seam allowance. Remember to move the sample fabric so you only pin the seam allowance and zipper tape. Hand baste in place then machine stitch.

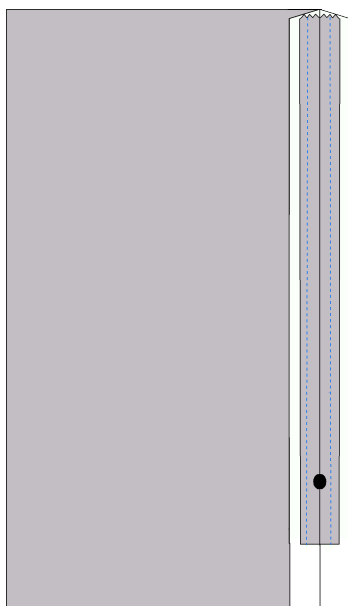

9. Turn the sample to the right side with the zipper closed. Press the seam and hand baste from just above the zipper stop (you can feel it through the fabric) and 1/4" away from the seam to the top on both sides.

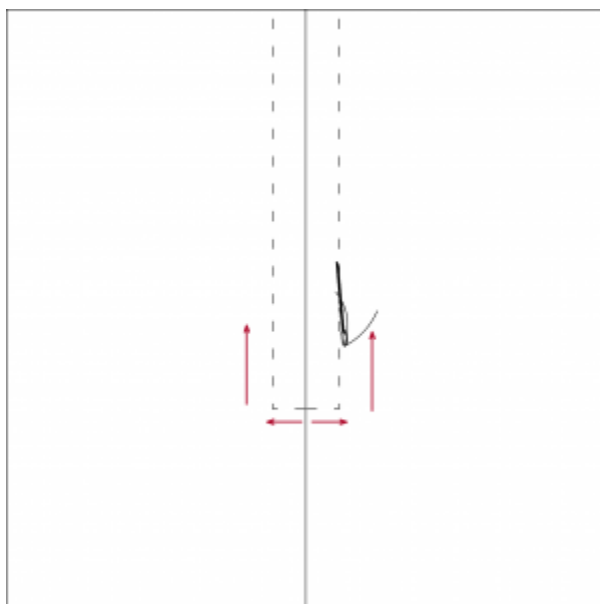

10. Using the notched zipper foot, machine stitch over the basting lines 1/4" from the seam on each side making sure you do not hit the zipper stop at the bottom.

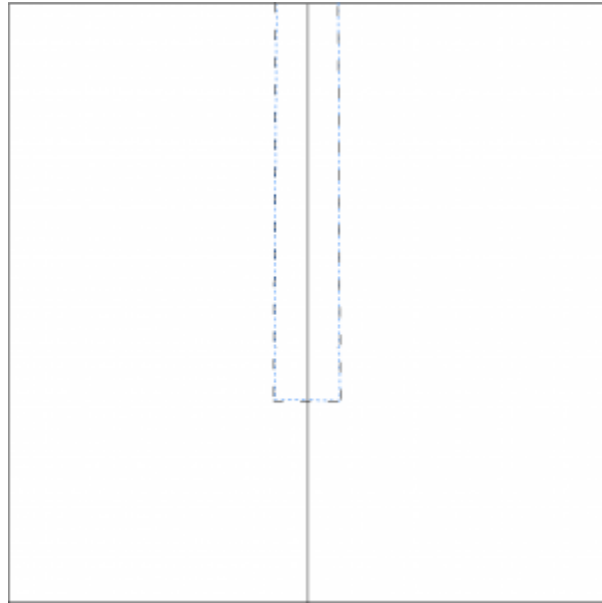

11. Remove basting stitches from stitching line.

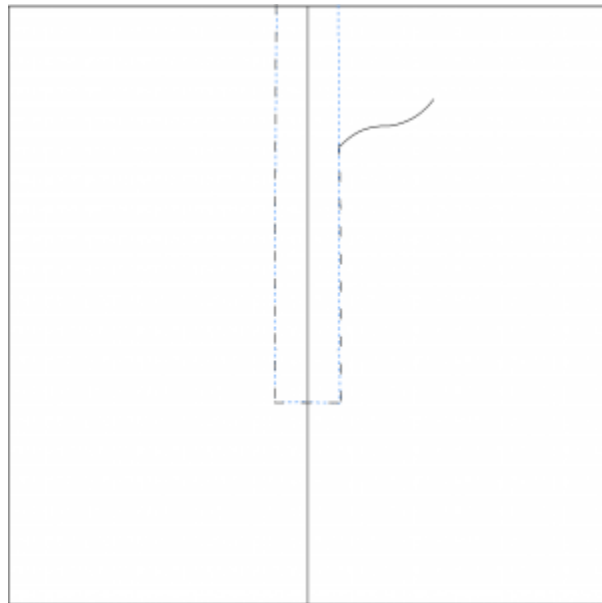

12. Remove basting stitches from seam line to expose zipper. Label "Center Zipper" and place in Sample Notebook.

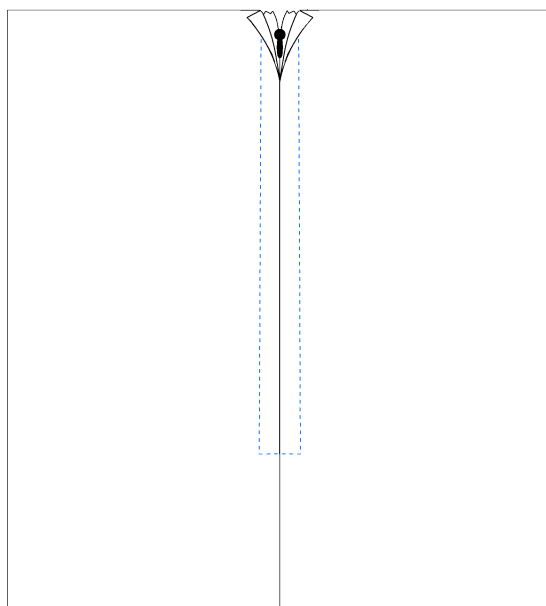

D. Hooks and Eyes – hooks and eyes are options for closures and come in a variety of sizes depending on the application and weight of fabric. You must use them in pairs. The regular hook can be used with either a round eye or a straight eye. The skirt hook is much larger and more stable. This hook and eye combinations is found on waistbands for skirts and pants for both men and women.

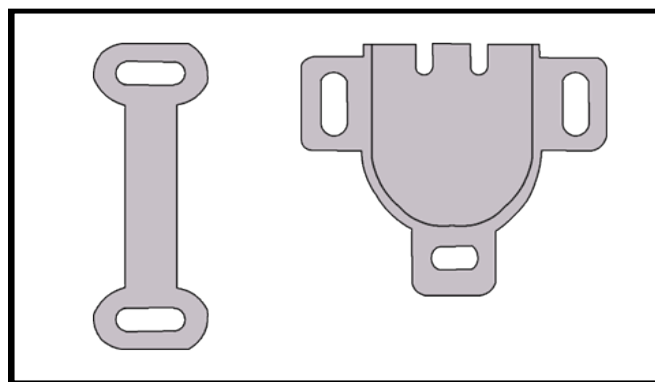
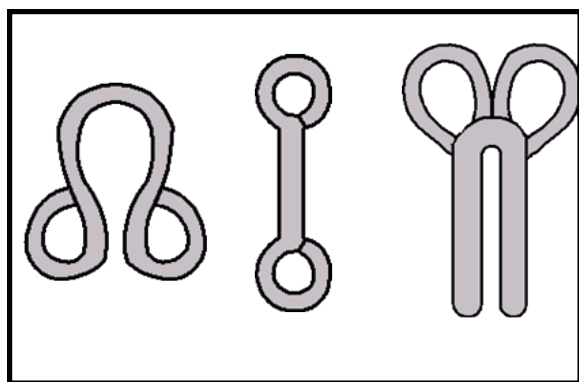

General Hook and Eye

1. Cut 2 pieces of sample fabric 4" by 5". Select 1 regular hood and round eye.



2. Using a hand sewing needle, thread the needle for double thread use. Take 1 length of thread about 10" long, double it, matching ends and thread ends through needle eye. When you begin your hand sewing you can run the needle through the loop to secure, avoiding a knot.



3. Starting from the top side (where you can see the hook, hold the hook in place and stitch around each eye. Then do the same for the round eye.

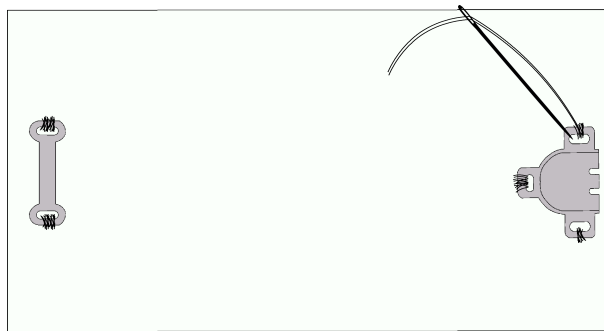

Close up view.

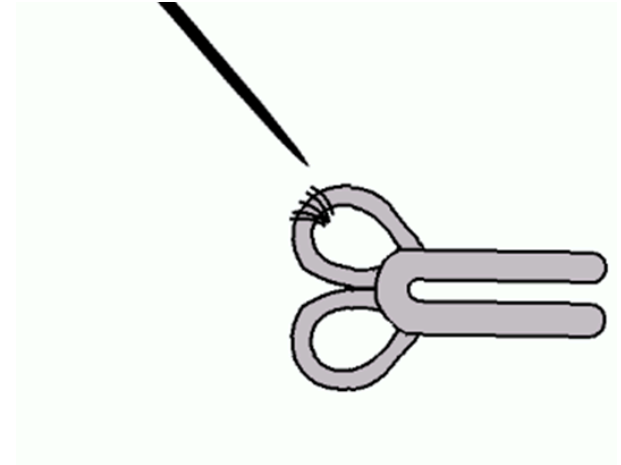

Skirt Hook and Eye

1. Cut 2 pieces of sample fabric 4" by 5". Select 1 skirt hook and flat eye.

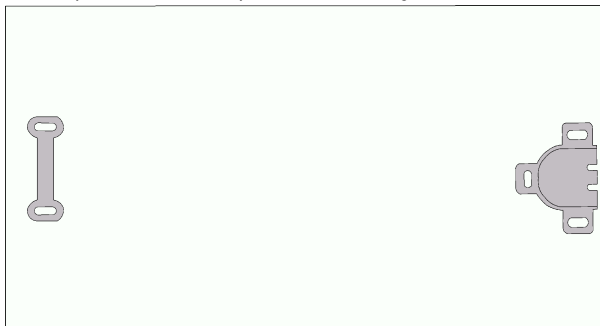

2. Using a hand sewing needle, thread the needle for double thread use. Take 1 length of thread about 10" long, double it, matching ends and thread ends through needle eye. When you begin your hand sewing you can run the needle through the loop to secure, avoiding a knot.



3. Starting from the top side (where you can see the hook, hold the hook in place and stitch around each section with a hole. Then do the same for the flat eye on both ends.

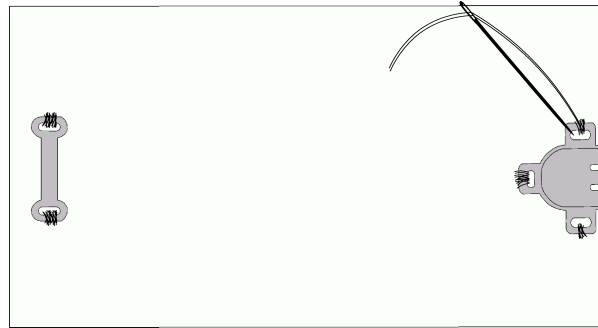

E. Buttons are used to close overlapping garment pieces. There are a variety of sizes and shapes to buttons including number of holes for sewing. A 4-hole button will be used for your shirt project as listed in the supply list.

1. Cut 2 pieces of sample fabric 4" by 5 ". Select 1 4-hole button. Thread a hand sewing needle with a double thread and knot one end. Start by inserting needle from the underside of the sample and come up through 1 eye of the button. Pull thread to the knot.

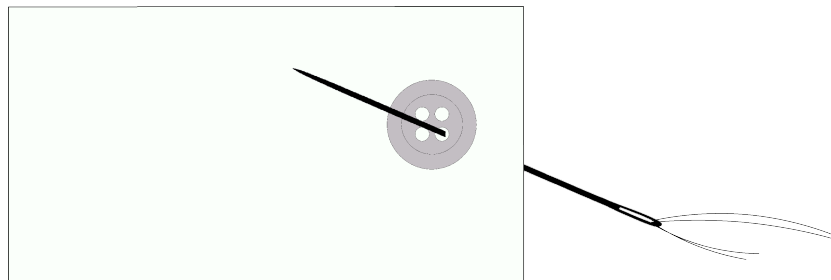

2. Insert the needle into the opposing eye diagonally.

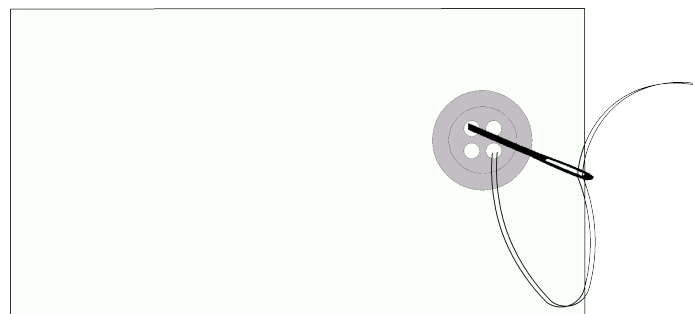

3. Continue stitching from the first hole to the second hole 4-5 times. Then insert needle from under the sample in the hole next to the first hole and stitch 4-5 times.

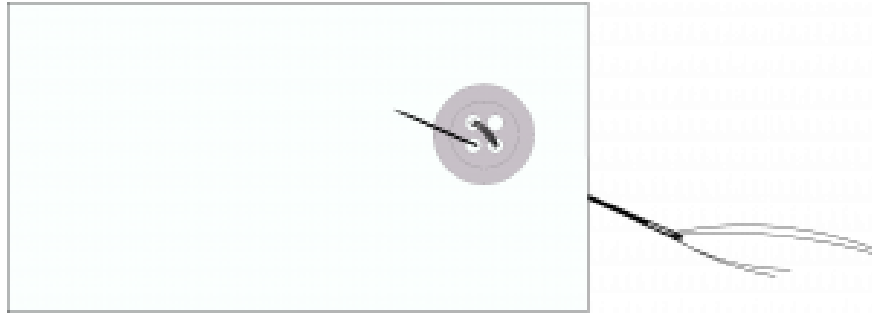

4. To secure the stitches, from the underneath side of the sample, run the needle under the crossed stitches 2 times and cut the thread.

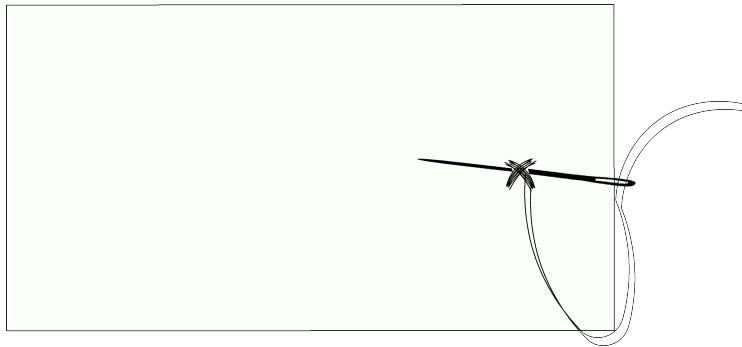

PART VII
UNIT 7 SEWING PROJECTS

15. Tote Bag



1. Tote Bag Patterns

You can either purchase the specific pattern (Simplicity S9298) for the tote bag or make a pattern from poster board. Tote Bag Pattern from Poster Board.

Tote Bag Pattern from Poster Board.

Outside of Tote Bag Patterns

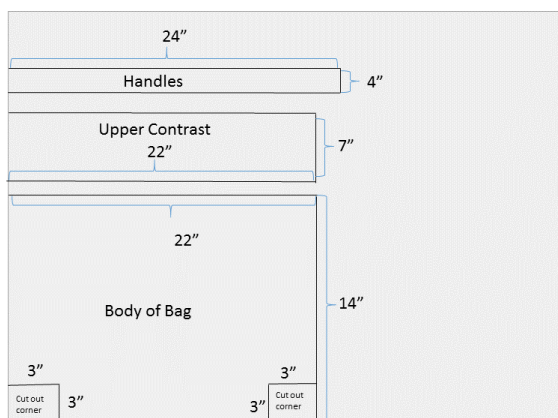

1. Handles
 - a. Draw a 24" by 4" box.
2. Upper Contrast
 - a. Draw a 22" by 7" box.
3. Body of Bag
 - a. Draw a 22" by 14" box.
 - b. Cut a 3" square out of each bottom corner.
4. Cut out all pieces from the poster board.

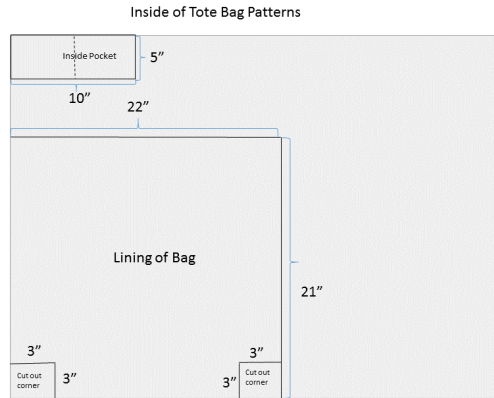

1. Pocket
 - a. Draw a 10" by 5" box.
 - b. Draw a dotted line in the center of the box.
2. Lining of Bag
 - a. Draw a 22" by 7" box.
3. Body of Bag
 - a. Draw a 22" by 21" box.
 - b. Cut a 3" square out of each bottom corner.
4. Cut out all pieces from the poster board.

2. Layout Tote Bag Patterns on Fabric.

You will need 3 fabrics for your tote bag, 1 for the body of the bag, 1 for the contrast trim and one for the lining. For the body of the bag, the fabric should be a cotton fabric that is heavier than apparel fabric. It can be upholstery fabric, but make sure it is not too heavy or it will be hard to sew. For contrast of the bag, the fabric should be the same weight as the body of the bag. It can be a contrasting color or pattern. For the lining, you will need a cotton shirting weight fabric. You will layout the tote bag patterns as shown.

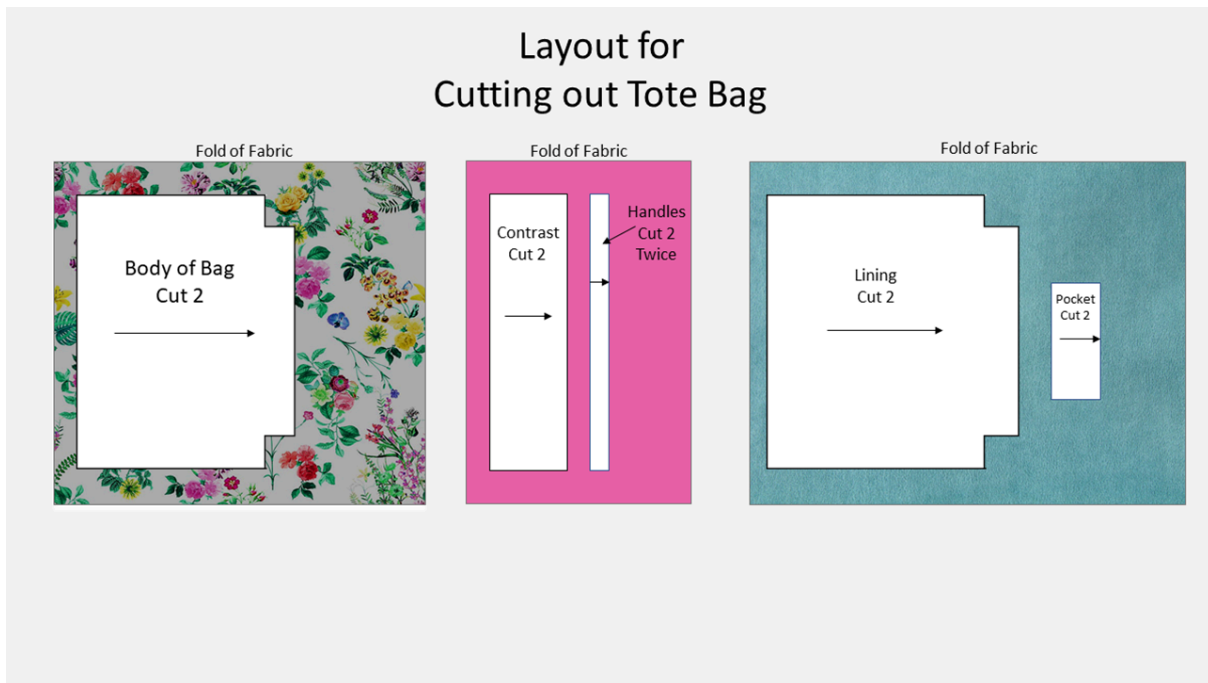

3. Tote Bag Instructions

Layout the Tote Bag pattern on chosen fabrics.

Cut out Tote Bag pattern pieces and fusible fleece.

Mark all pieces of Tote Bag Pattern. Tote Bag Video #1

Sew body of bag side 1 to contrast band side 1. Press seams open.

Sew body of bag side 2 to contrast band side 2. Press seams open.

Fuse Fusible Fleece on both side 1 and side 2 of body of bag. Tote Bag Video #1



One or more interactive elements has been excluded from this version of the text. You can view them online here: <https://uark.pressbooks.pub/introapparelproductionworkbook/?p=122#oembed-1>

Sew body of side 1 and side 2 at the side seams to the corner, press seams open and trim.

Sew the bottom of side 1 and side 2 of the bag to the corner, press seam open and trim.

Sew the corner seam, trim. Tote Bag Video #2

Sew each strap wrong sides together, trim. Turn right side out and press.

Top stitch straps at $\frac{1}{4}$ " and $\frac{1}{2}$ " from each edge.

Place the straps on each side of the bag at markings and staystitch in place.

Tote Bag Video #2



One or more interactive elements has been excluded from this version of the text. You can view them online here: <https://uark.pressbooks.pub/introapparelproductionworkbook/?p=122#oembed-2>

Sew darts in both pocket pieces making sure the darts line up with each other when placed right side together.
Sew pocket together all the way around leaving a 3 inch opening at the bottom (dart side). Turn right side out through the opening. Press.

Sew pocket on one lining piece (right side). Stitch the sides and bottom. This will close the opening. Turn right side out through the opening.

Sew sides of lining together, trim and press seams open.

Sew bottom of lining together leaving a 5" opening, trim stitched areas and press open.

Sew corners of lining, trim. Tote Bag Video #3



One or more interactive elements has been excluded from this version of the text. You can view them online here: <https://uark.pressbooks.pub/introapparelproductionworkbook/?p=122#oembed-3>

With bag right side out and lining wrong side out, place bag inside of lining.

Tuck straps in between bag and lining and match side seams, pin.

Sew around top of bag, trim. Tote Bag Video #4

Turn bag right side out using the opening in the lining. Tuck the lining inside the bag. Tote Bag Video #4

Press top of bag.

Sew a top stitch around the top of bag with straps pulled up.

Edge stitch the lining opening closed. Tote Bag Video #4



One or more interactive elements has been excluded from this version of the text. You can view them online here: <https://uark.pressbooks.pub/introapparelproductionworkbook/?p=122#oembed-4>

16. Skirt

Skirt Pattern: Simplicity 1559 View D

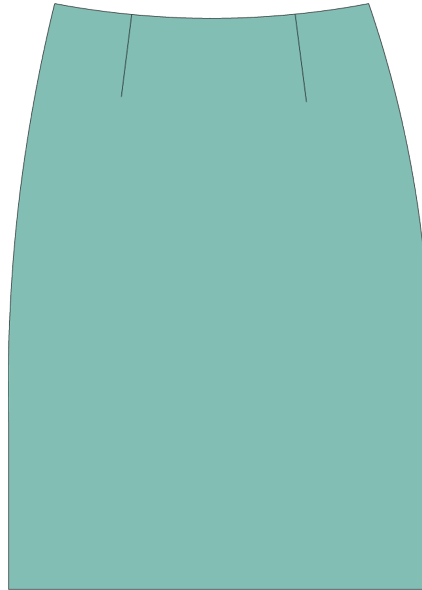

Skirt Front

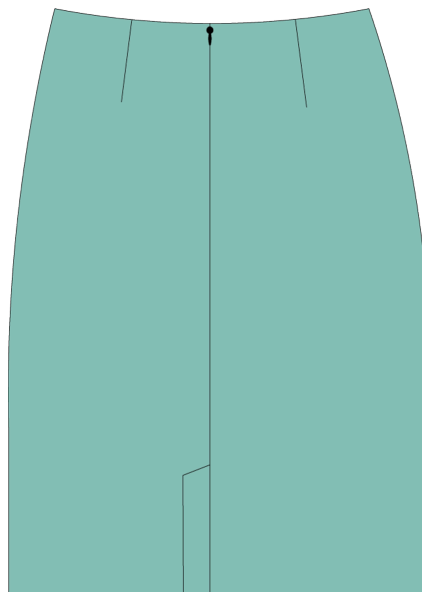

Skirt Back

Lay out pattern pieces on fabric and interfacing.

Cutting out and marking skirt.

Mark all symbols on the skirt pieces. Skirt Video #1

Serge the side seams and back seam of skirt front and back pieces.

Sew darts on skirt front and skirt back pieces. Skirt Video #2



One or more interactive elements has been excluded from this version of the text. You can view them online here: <https://uark.pressbooks.pub/introapparelproductionworkbook/?p=124#oembed-1>

Insert invisible zipper in center back.

Sew the back seam from bottom of zipper and bottom edge. Press open.

Sew sides seams together. Press open. Skirt Video #2



One or more interactive elements has been excluded from this version of the text. You can view them online here: <https://uark.pressbooks.pub/introapparelproductionworkbook/?p=124#oembed-2>

Fuse interfacing to Facing. Skirt Video #3

Serge the unnotched edge of the facing.

Sew notched side of the facing to skirt matching symbols.

Press seam up into the waistband.

Edgestitch facing. Skirt Video #3

Fold facing over right side of zipper.

Stitch close to zipper teeth the width of the facing.

Repeat on the other side. Skirt Video #3

Using a hook and eye, place the hook side on the inside left side of the facing at the edge. Hand s

Place eye on the opposite side. Hand stitch the eye in place. Skirt Video #3

Using the flat part (eye), place it on the outside right side of the waistband. Place it where the h
in place.



One or more interactive elements has been excluded from this version of the text. You can view them online here: <https://uark.pressbooks.pub/introapparelproductionworkbook/?p=124#oembed-3>

Serge around the hem of the skirt.

Turn hem to inside of the skirt at the desired length.

Press in place and pin if necessary. Skirt Video #4

Hem the skirt using the blind catch stitch.

Press. Skirt Video #4



One or more interactive elements has been excluded from this version of the text. You can view them online here: <https://uark.pressbooks.pub/introapparelproductionworkbook/?p=124#oembed-4>

17. Shirt

Simplicity Pattern



Shirt Front



Shirt Back

Layout of Shirt Pattern on Fabric.

1. Shirt Front
3. Front Band
4. Shirt Back
6. Back Yoke
7. CollarBand
8. Collar
9. Sleeve
10. Sleeve Placket
11. Cuff

- Interfacing
3. Front Band (2)
 7. CollarBand (1)
 8. Collar (1)
 11. Cuff (4)

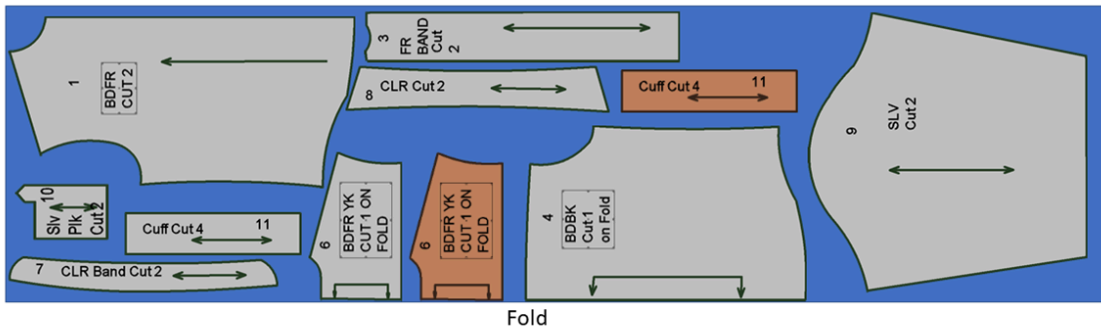
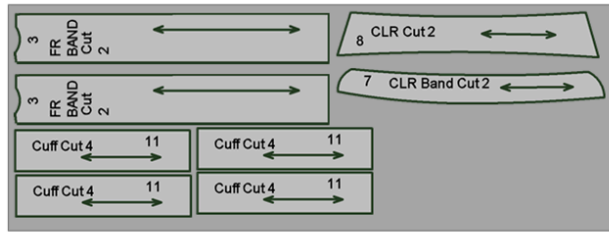

Lay out pattern pieces on fabric and interfacing.

Cutting out and marking shirt.

Mark all symbols on the shirt pieces. Shirt Video #1

Apply interfacing to appropriate pieces. Shirt Video #1



One or more interactive elements has been excluded from this version of the text. You can view them online here: <https://uark.pressbooks.pub/introapparelproductionworkbook/?p=126#oembed-1>

Staystitch neckline on both front and back pieces.

If placing pocket, staystitch around the pocket folding under the top of the pocket.

Stitch pocket on bodice front (either left or right or both for 2 pockets where indicated. Press. Shirt Video #2

Roll the back bodice piece up to fit inside the yoke pieces and pin.

Stitch back to front pieces at shoulder seams.

Pull shirt through one of the openings at the armhole to turn right side out.

Topstitch yoke 1/8" and 1/4" from yoke seam. Shirt Video #2



One or more interactive elements has been excluded from this version of the text. You can view them online here: <https://uark.pressbooks.pub/introapparelproductionworkbook/?p=126#oembed-2>

Place sleeve placket on the wrong side of sleeves where designated.

Stitch. Cut opening for each sleeve placket.

Turn placket to outside of sleeve and edge stitch to secure.

Pin pleats on sleeves in place and staystitch.

Shirt Video #3

Pin sleeve to bodice armscye easing to fit.

Stitch undersleeve and side seams in one continuous stitch.

Serge both sleeve/side seams.

Serge the bottom (hem) of shirt. Shirt Video #3



One or more interactive elements has been excluded from this version of the text. You can view them online here: <https://uark.pressbooks.pub/introapparelproductionworkbook/?p=126#oembed-3>

Sew cuffs pieces together wrong sides together with one side turned under $\frac{1}{2}$ ". Trim. Turn cuffs to right side. Press.

Pin to sleeve to cuff, matching cuff edges to placket opening edges.

Stitch cuff to sleeve. Trim seam allowance and press up into the cuff.

Take the folded cuff edge and pin it over the seam. Hand stitch the cuff closed using a slip stitch.

Topstitch around cuff $\frac{1}{8}$ " and $\frac{1}{4}$ " from edge. Shirt Video #4

Stitch notched edge of front plackets to each side of front bodice.

Fold plackets toward under side of bodice and staystitch in place at top.

Shirt Video #4

Stitch upper and under collar together, right sides together.

Turn under edge of one collarband piece $\frac{1}{2}$ " and press.

Pin collar between upper and under collar band matching notches.

Stitch collar to collarband.

Stitch collarband to shirt neckline. Hand baste collarband on the under side. Shirt Video #4



One or more interactive elements has been excluded from this version of the text. You can view them online here: <https://uark.pressbooks.pub/introapparelproductionworkbook/?p=126#oembed-4>

Turn hem under $\frac{1}{4}$ " and press. Turn another $\frac{1}{4}$ " and pin.

Topstitch hem all the way around shirt bottom. Shirt Video #5

Fold the front plackets right side together and stitch at bottom even with the hem of the skirt.

Mark buttonholes on the front plackets and cuffs.

Stitch buttonholes on front plackets (left side for men's, right side for women's) and cuffs.

Sew buttons on the opposite placket and cuffs.

Press. Shirt Video #5



One or more interactive elements has been excluded from this version of the text. You can view them online here: <https://uark.pressbooks.pub/introapparelproductionworkbook/?p=126#oembed-5>

18. Pants

Pants Pattern Simplicity



Place patterns on fabric along straight of grain.

Cut out pants pattern pieces.

Transfer marking symbols in pants pattern pieces.

With right sides together, place back of one pant leg to front of one pant leg and stitch inseam.

Then stitch side seam of pant same pant leg. Repeat for the other leg.

Serge all seams.

With one pant leg right side out and the other wrong side out, place the right side out pant leg INSIDE the wrong side out pant leg.

Match crotch seam curve.

Stitch crotch seam. Serge Pants.

Serge around the top of the pants.

Fold under 1.25" and press in place.

Topstitch at 1" around the top of the pants leaving a 1 inch opening.

Serge around the top of the pants.

Fold under 1.25" and press in place.

Topstitch at 1" around the top of the pants leaving a 1" opening for elastic casing.

Cut 3/4" elastic to desired waist measurement. Place a safety pin in the end of the elastic. Thread through the opening at the top of the pants.

Once the elastic is complete threaded and ends are showing through the opening, stitch elastic together at ends.

Topstitch the opening closed.

Mark hem.

Trim if necessary and serge hemline.

Turn under hem at desired length and pin.

Machine stitch hem at 1" mark above hem line. Press.



One or more interactive elements has been excluded from this version of the text. You can view them online here: <https://uark.pressbooks.pub/introapparelproductionworkbook/?p=128#oembed-1>

This is where you can add appendices or other back matter.